



Vector™ Multi-Cook Oven Simple Control

VMC-H2

VMC-H2H

VMC-H3

VMC-H3H

VMC-H4

VMC-H4H



Structured Air Technology™

MN-46543-EN

REV.01
11/19

EN



Manufacturer's Information

Copyright © Copyright 11/19 by Alto-Shaam, Inc.
All rights reserved.
This manual or any portion thereof may not be reproduced or used in any manner whatsoever without the express written permission of Alto-Shaam, Inc.

Trademarks All trademarks referenced in this documentation are the property of their respective owners.

Manufacturer Alto-Shaam, Inc.
P.O. Box 450
W164 N9221 Water Street
Menomonee Falls, WI 53052

Original instructions The content in this manual is written in American English.

Alto-Shaam 24/7 Emergency Repair Service

Call	Call 800-558-8744 to reach our 24-hour emergency service call center for immediate access to local authorized service agencies outside standard business hours. The emergency service access is provided exclusively for Alto-Shaam equipment and is available throughout the United States through Alto-Shaam's toll free number.
Availability	Emergency service access is available seven days a week, including holidays.

This page intentionally left blank.

Manufacturer's Information	2
Foreword	3
Alto-Shaam 24/7 Emergency Repair Service	3
Table of Contents	5
Safety	7
The Meaning of Signal Words	7
Safety Precautions.	8
Operation	11
How to Turn On and Turn Off the Oven	11
How to Update the Interface Board (IB)	12
How to Update the Control Board (CB)	14
How to Load Configuration Files	16
Components	19
Component Identification	19
Chamber Identification	20
Front Panel Identification	21
Back Panel Identification	22
Component Access Panels Identification	23
H4—Electrical Component Identification	24
H3—Electrical Component Identification	25
H2—Electrical Component Identification	26
Electrical Components	27
Left Service Panel Identification	38
Left Service Panel Components	39
Right Service Panel Identification	42
Right Service Panel Components	43
Internal Components Identification	45
Internal Components	46
Theory	47
Standby State	47
On State	48
Preheat State.	49
Idle State	50
Cooking State	51
Cooking State Complete	52
Rapid ON/OFF State	53
Cool Down State	54
Cool Down State Complete.	55

Maintenance	57
Maintenance Schedule	57
How to Clean the Oven.	58
Testing	63
How to Test the Cooling Fans	63
How to Test the Blower Motors	65
How to Test the Heaters	68
How to Calibrate a Chamber Thermocouple	71
Troubleshooting	75
Error Messages	75
The Oven will not Power Up	76
The Screen will not Turn On	78
The Screen will not power down or the oven will not enter cool down mode	79
The Screen is Solid White	80
The Screen is not Responsive/Incorrect Response to the Selected Icon	81
The Screen has Icons, but no Text	82
The Striped Screen is Locked—Continuous Chamber(s) do not Heat—Solid State Relay (SSR) Control Voltage not Present	84
The Chamber(s) do not Heat—Heater Element Line Voltage (SSR is Energized).	86
The Chamber is Slow to Heat	89
A Single Chamber Blower Fan does not Operate	90
All Chamber Blower Fans do not Operate	91
Chamber Light do not Illuminate	92
The Check Fan Indicator Light is Illuminated	93
The Cooling Fan(s) do not Operate	94
Assembly/Disassembly	97
Removing and Installing the Blower Motor	97
Removing and Installing a Heater Element	99
Schematics	101

The Meaning of Signal Words

This manual contains signal words where needed. These signal words must be obeyed to reduce the risk of death, personal injury, or equipment damage. The meaning of these signal words is explained below.

**DANGER**

Danger indicates a hazardous situation which, if not avoided, will result in serious injury or death.

**WARNING**

Warning indicates a hazardous situation which, if not avoided, could result in serious injury or death.

**CAUTION**

Caution indicates a hazardous situation which, if not avoided, could result in minor or moderate injury.

NOTICE

Notice indicates a situation which, if not avoided, could result in property damage.



NOTE: Note indicates additional information that is important to a concept or procedure.

Safety Precautions

Before you begin

Read and understand all instructions in this manual.

Electrical precautions

Obey these electrical precautions when using the appliance:

- Connect the appliance to a properly grounded outlet. Do not use the appliance if it is not properly grounded. Consult an electrician if there is any doubt that the outlet used is properly grounded.
 - Keep the cord away from hot surfaces.
 - Do not attempt to service the appliance or its cord and plug.
 - Do not operate the appliance if it has a damaged cord or plug.
 - Do not immerse the cord or plug in water.
 - Do not let the cord hang over the edge of a table or counter.
 - Do not use an extension cord.
-

Usage precautions

Obey these usage precautions when using the appliance:

- Only use this appliance for its intended use of heating or cooking.
 - Always keep liquids, or foods that can become liquid when heated, level and at or below eye level where they can be seen.
 - Use utensils and protective clothing such as dry oven mitts when loading and unloading the appliance.
 - Use caution when using the appliance. Floors adjacent to the appliance may become slippery.
 - Do not cover or block any of the openings of this appliance.
 - Do not cover racks or any other part of this appliance with metal foil.
 - Do not use this appliance near water such as a sink, in a wet location, near a swimming pool, or similar locations.
 - Do not unplug or disconnect the appliance immediately after cooking. The cooling fans must stay on to protect electrical components.
-

Maintenance precautions

Obey these maintenance precautions when maintaining the appliance:

- Obey precautions in the manual, on tags, and on labels attached to or shipped with the appliance.
- Only clean the appliance when the main disconnect switch is in the OFF position.
- Do not store the appliance outdoors.
- Do not clean the appliance with metal scouring pads.
- Do not use corrosive chemicals when cleaning the appliance.
- Do not use a hose or water jet to clean the appliance.
- Do not use the appliance cavity for storage.
- Do not leave flammable materials, cooking utensils, or food inside the appliance when it is not in use.
- Do not remove the top cover or side panels. There are no user-serviceable components inside.

Operator training

All personnel using the appliance must have proper operator training. Before using the appliance:

- Read and understand the operating instructions contained in all the documentation delivered with the appliance.
 - Know the location and proper use of all controls.
 - Keep this manual and all supplied instructions, diagrams, schematics, parts lists, notices, and labels with the appliance if the appliance is sold or moved to another location.
 - Contact Alto-Shaam for additional training if needed.
-

Operator qualifications

Only trained personnel with the following operator qualifications are permitted to use the appliance:

- Have received proper instruction on how to use the appliance.
- Have demonstrated their ability with commercial kitchens and commercial appliances.

The appliance must not be used by:

- Persons (including children) with reduced physical, sensory or mental capabilities, or lack of experience and knowledge, unless they have been given supervision concerning use of the appliance by person responsible for their safety.
 - People impaired by drugs or alcohol.
-

- Children should be supervised to ensure that they do not play with the appliance.
 - Children shall neither clean nor maintain the appliance.
-

Condition of appliance

Only use the appliance when:

- All controls operate correctly.
 - The appliance is installed correctly.
 - The appliance is clean.
 - The appliance labels are legible.
-

Servicing the appliance

- Only trained personnel are permitted to service or repair the appliance. Repairs that are not performed by an authorized service partner or trained technician, or the use of non-factory parts, will void the warranty and relieve Alto-Shaam of all liability.
 - To prevent serious injury, death or property damage, have the appliance inspected and serviced at least every twelve (12) months by an authorized service partner or trained technician.
 - Contact Alto-Shaam for the authorized service partner in your area.
-

Sound power

The A-weighted sound pressure level is below 70 dB(A).

Personal Protective Equipment (PPE)

Wear the following Personal Protective Equipment (PPE) while cleaning the appliance:

- Protective gloves
 - Protective clothing
 - Eye protection
 - Face protection
-

Service Technician Training

Only trained personnel are permitted to service or repair the appliance. Service technicians must be knowledgeable in current codes and standards as stated by the appropriate agencies, such as:

- The National Fire Protection Association (NFPA)
- National Electrical Code (NEC)
- The Service Technician's employer

How to Turn On and Turn Off the Oven

Before you begin

The oven must be connected to electric power.

Turning on the oven

To turn on the oven, do the following.

Step	Action
1.	<p>Set the main disconnect switch ① to the ON position.</p> <p>Press the ON/OFF button ②. The LED on the button illuminates green.</p>
<p>NOTE: The main disconnect switch is meant to be used during cleaning or service operations. For every day operation, it may be left in the ON position.</p>	
	

- Set** the main disconnect switch ① to the ON position.

Press the ON/OFF button ②. The LED on the button illuminates green.

NOTE: The main disconnect switch is meant to be used during cleaning or service operations. For every day operation, it may be left in the ON position.

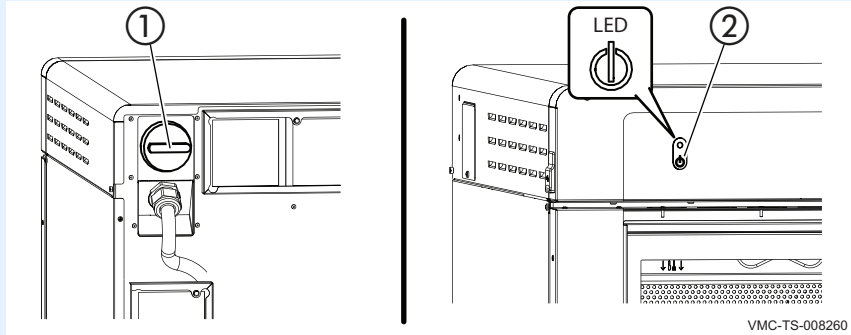

The oven is now on.

Turning off the oven

To turn off the oven, do the following.

- Press and hold** the ON/OFF button until the LED above the ON/OFF button illuminates red.

The oven activates the blowers for the cool down process. The screen displays a cool down prompt and asks for the door to be opened. The oven will deactivate the blowers when the cool down process is complete.

The oven is now off.

How to Update the Interface Board (IB)

Before you begin

- The chambers should be off (not preheated).
- Do not remove the USB drive during the update process.
- You will need a USB drive with the updated firmware.
- You will need to know the service pass code.

Procedure

To update the interface board, do the following.

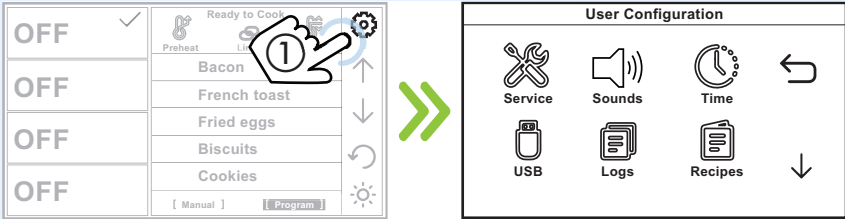
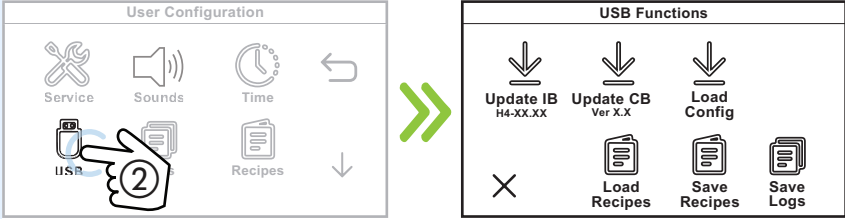
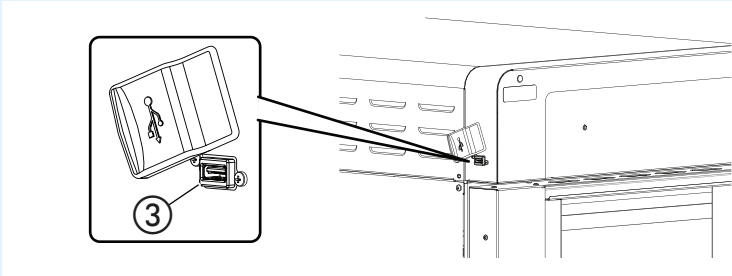
Step	Action
1.	<p>Touch the gear icon ①. The User Configuration screen displays.</p>  <p style="text-align: right; font-size: small;">VMC-TS-007669</p>
2.	<p>Touch the USB icon ②. The USB Functions screen displays.</p>  <p style="text-align: right; font-size: small;">VMC-TS-007849</p>
3.	<p>Plug the USB drive into the port ③.</p>  <p style="text-align: right; font-size: small;">VMC-TS-007852</p>

NOTICE Do not remove the USB drive during the update process.

Continued on next page

Continued from previous page

4. **Touch** the Update IB icon ④. The Enter Pass Code screen displays.
Enter the pass code 6702 ⑤.
Touch the green check mark ⑥.

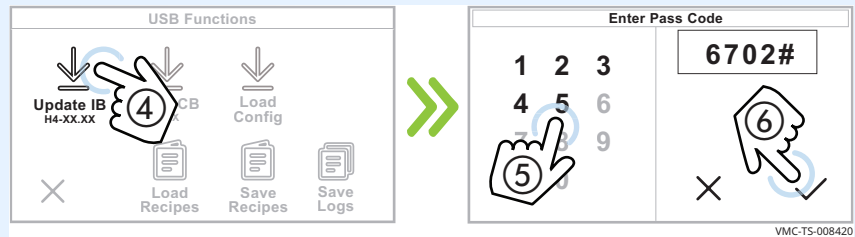

5. **Touch** the firmware file ⑦ for your particular oven—choose by oven size. The oven loads the selected firmware.

NOTICE Do not remove the USB drive during the update process.

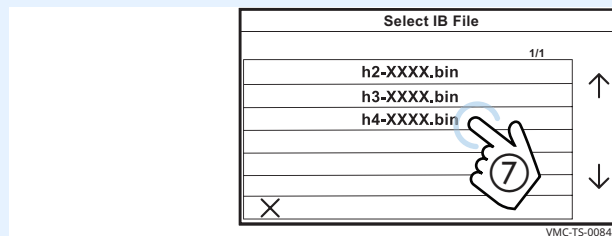

The oven goes through the update process:

- The screen goes blank.
- The striped screen displays for a few seconds.
- The screen goes blank.
- The logo screen displays for a few seconds.
- The oven turns off.

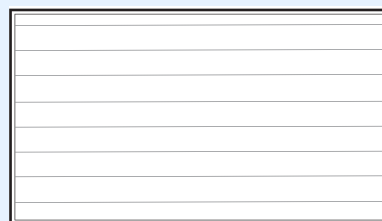

6. **Press** the ON/OFF button to turn on the oven and complete the update process.

Result

The interface board has now been updated

How to Update the Control Board (CB)

Before you begin

- The chambers should be off (not preheated).
- Do not remove the USB drive during the update process.
- You will need a USB drive with the updated firmware.
- You will need to know the service pass code.

Procedure

To update the control board, do the following.

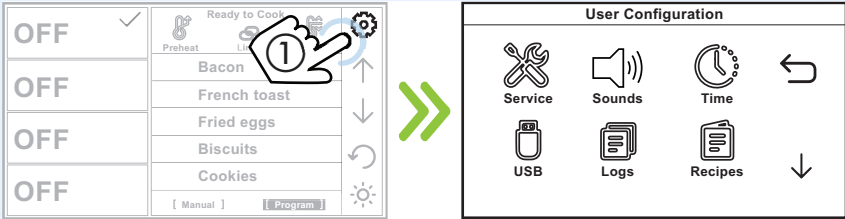
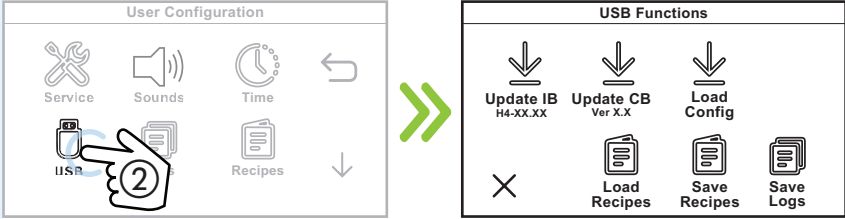
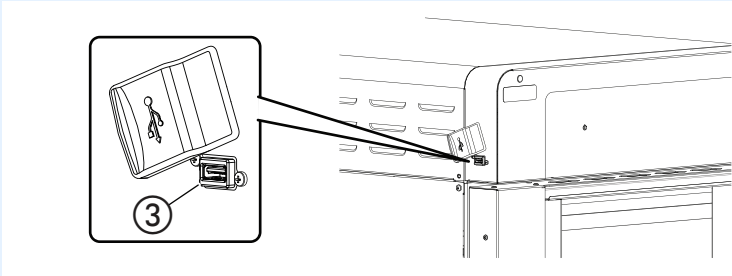
Step	Action
1.	<p>Touch the gear icon ①. The User Configuration screen displays.</p>  <p style="text-align: right; font-size: small;">VMC-TS-007669</p>
2.	<p>Touch the USB icon ②. The USB Functions screen displays.</p>  <p style="text-align: right; font-size: small;">VMC-TS-007849</p>
3.	<p>Plug the USB drive into the port ③.</p>  <p style="text-align: right; font-size: small;">VMC-TS-007852</p>

NOTICE Do not remove the USB drive during the update process.

Continued on next page

Continued from previous page

4. **Touch** the Update CB icon ④. The Enter Pass Code screen displays.
Enter the pass code 6702 ⑤.
Touch the green check mark ⑥.

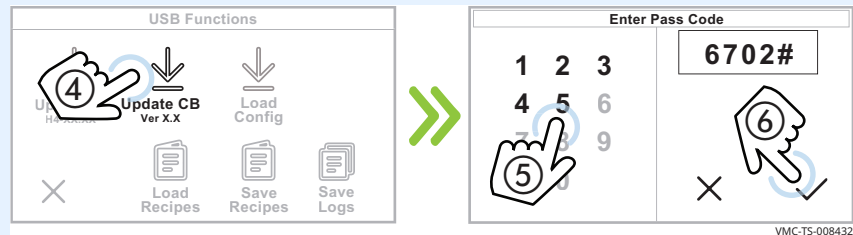

5. **Touch** the firmware file ⑦. The oven loads the selected firmware.

NOTICE Do not remove the USB drive during the update process.

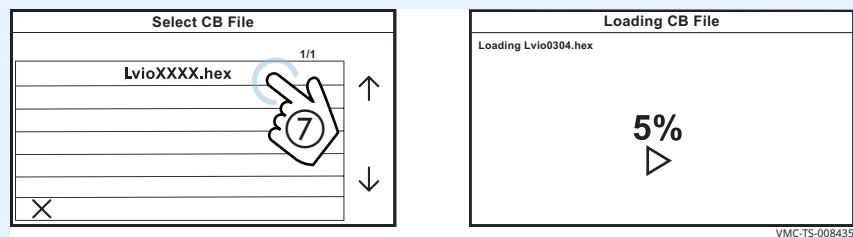

The oven goes through the update process:

- The screen goes blank.
- The striped screen displays for a few seconds.
- The screen goes blank.
- The logo screen displays for a few seconds.
- The oven turns off.

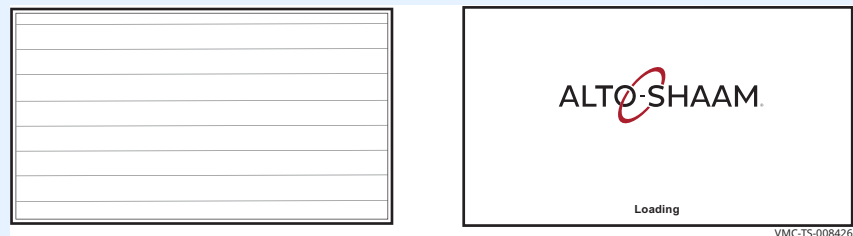

6. **Press** the ON/OFF button to turn on the oven and complete the update process.

Result

The control board has now been updated.

How to Load Configuration Files

Before you begin

- The chambers should be off (not preheated).
- Do not remove the USB drive during the update process.
- You will need a USB drive with the configuration files.
- You will need to know the service pass code.

Procedure

Configuration files are used to load the oven menu.

To load a menu to the oven, do the following.

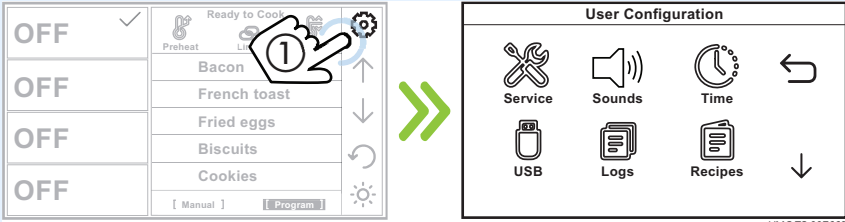
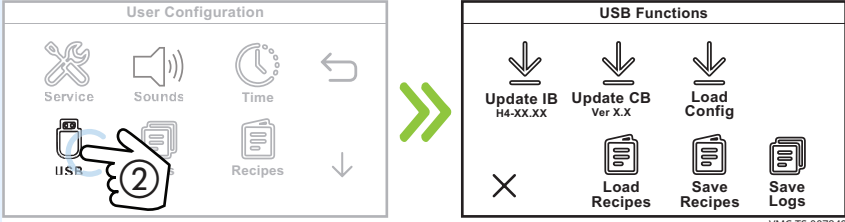
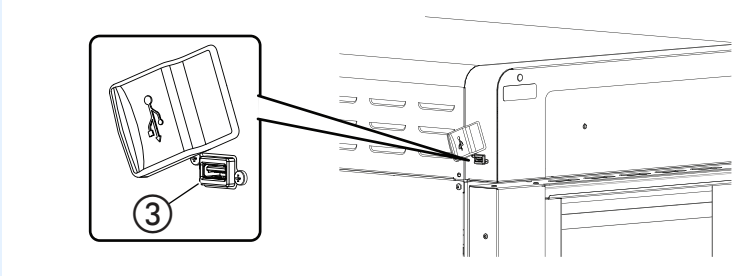
Step	Action
1.	<p>Touch the gear icon ①. The User Configuration screen displays.</p>  <p style="text-align: right; font-size: small;">VMC-TS-007669</p>
2.	<p>Touch the USB icon ②. The USB Functions screen displays.</p>  <p style="text-align: right; font-size: small;">VMC-TS-007849</p>
3.	<p>Plug the USB drive into the port ③.</p>  <p style="text-align: right; font-size: small;">VMC-TS-007852</p>

NOTICE Do not remove the USB drive during the update process.

Continued on next page

Continued from previous page

4. **Touch** the Load Config icon ④. The Enter Pass Code screen displays.
Enter the pass code 6702 ⑤.
Touch the green check mark ⑥.

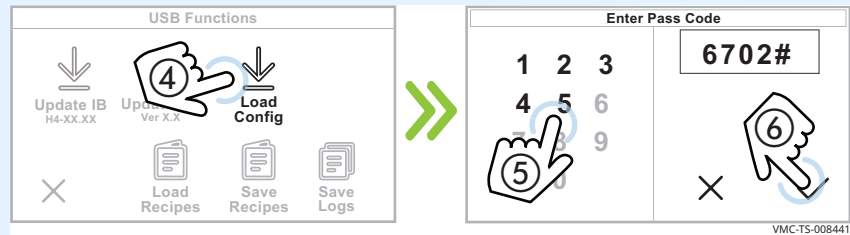

5. **Touch** the configuration file ⑦. The oven loads the selected firmware.

NOTICE Do not remove the USB drive during the update process.

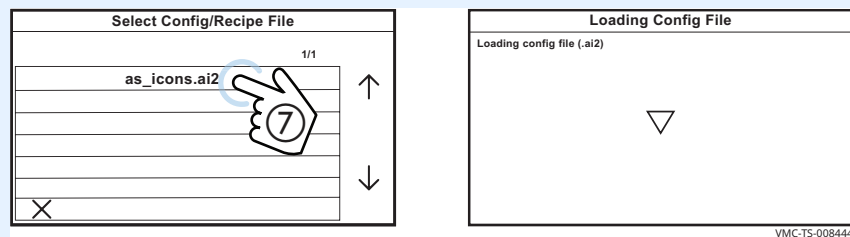

The oven goes through the update process:

- The screen goes blank.
- The striped screen displays for a few seconds.
- The screen goes blank.
- The logo screen displays for a few seconds.
- The oven turns off.

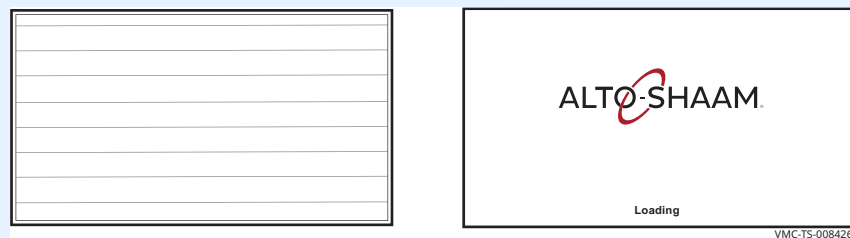

6. **Press** the ON/OFF button to turn on the oven and complete the update process.

Result

The configuration file has now been loaded.

This page intentionally left blank.

Component Identification



COMPONENTS

Chamber Identification

Components will be identified in accordance with the chamber numbering illustrated here.

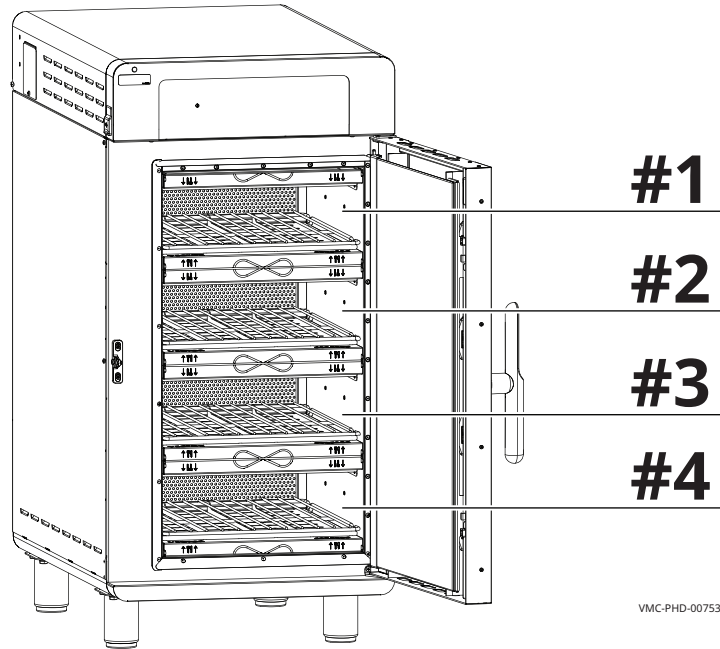

Front Panel Identification

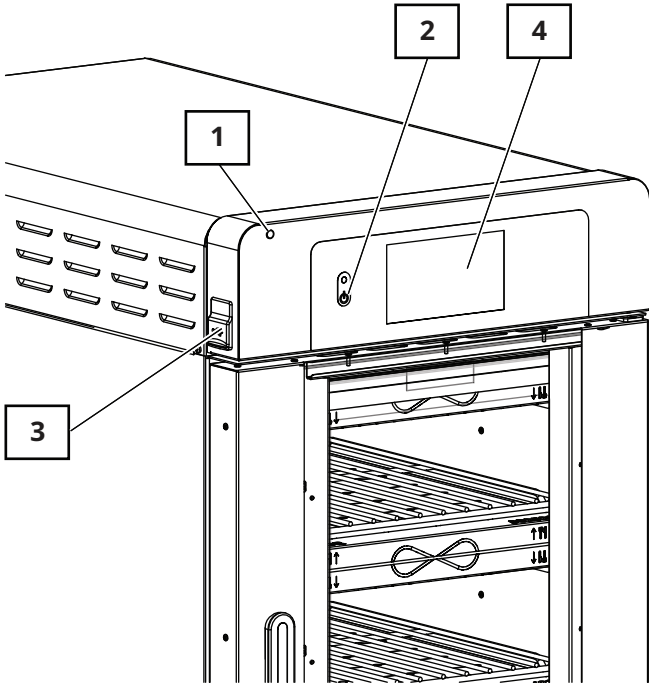

VMC-PHD-008452

Ref.	Description
1	Check fans indicator light
2	ON/OFF button
3	USB port
4	Control panel display

Back Panel Identification

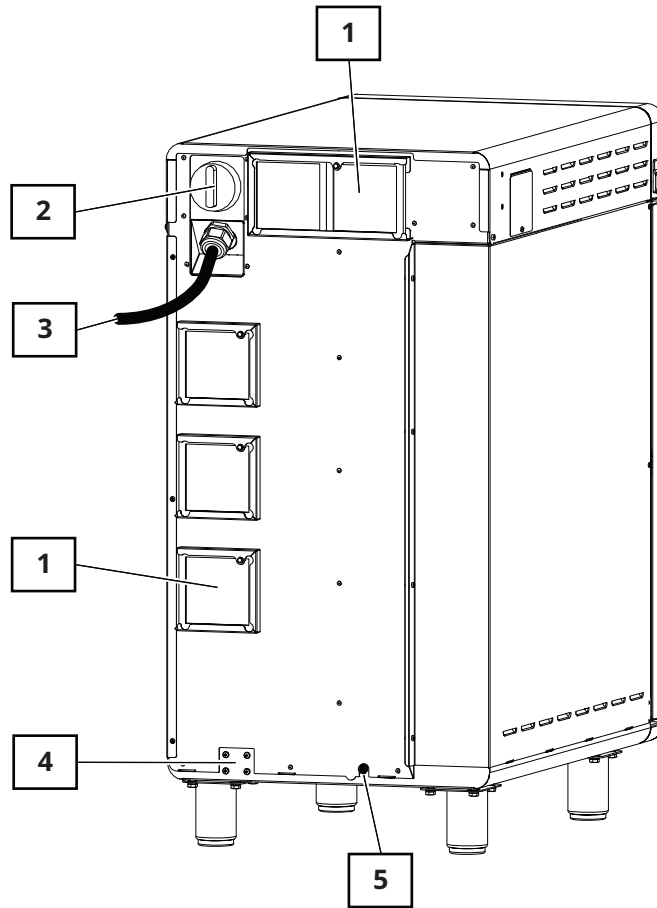

VMC-PHD-007536

Ref.	Description
1	Cooling Fans/Filters
2	Main disconnect switch
3	Electrical supply cord
4	Tether ring mount
5	Equipotential-bonding terminal

Component Access Panels Identification

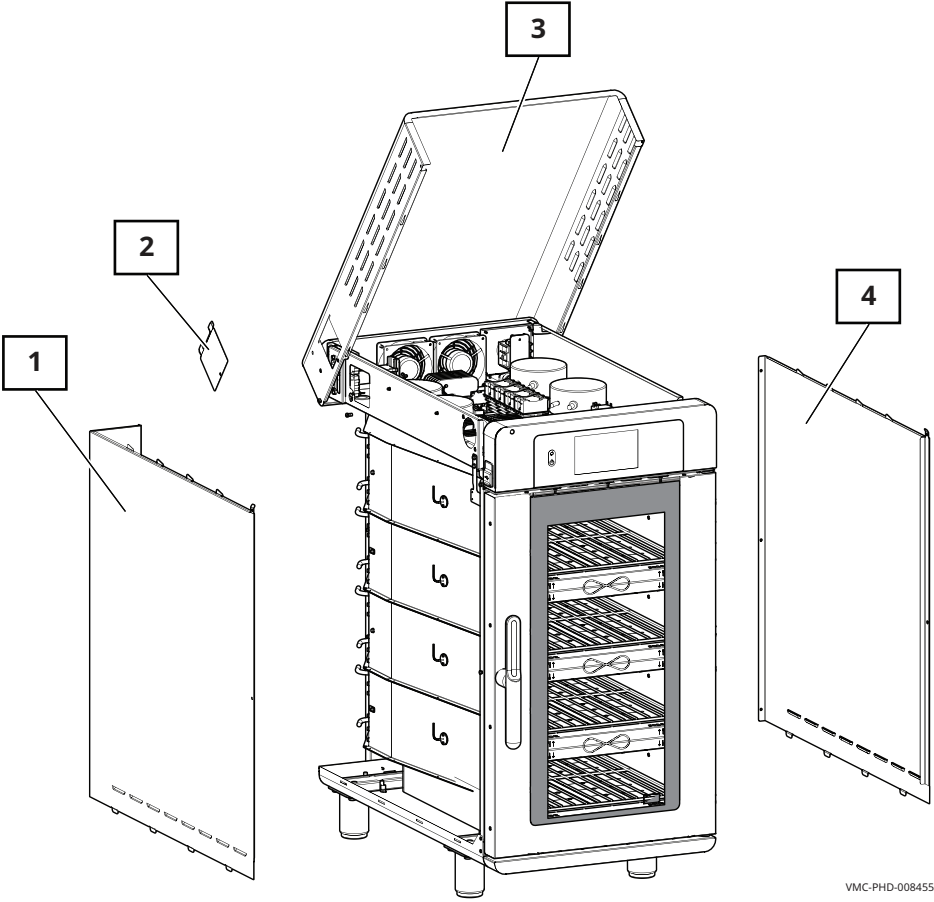

VMC-PHD-008455

Ref.	Description	Provides access to
1	Left service panel	Heating elements, catalyst, and thermocouples
2	Circuit breaker access panel	Circuit breakers
3	Top service panel	Electrical components
4	Right service panel	Blower motors and cooling fans

H4—Electrical Component Identification

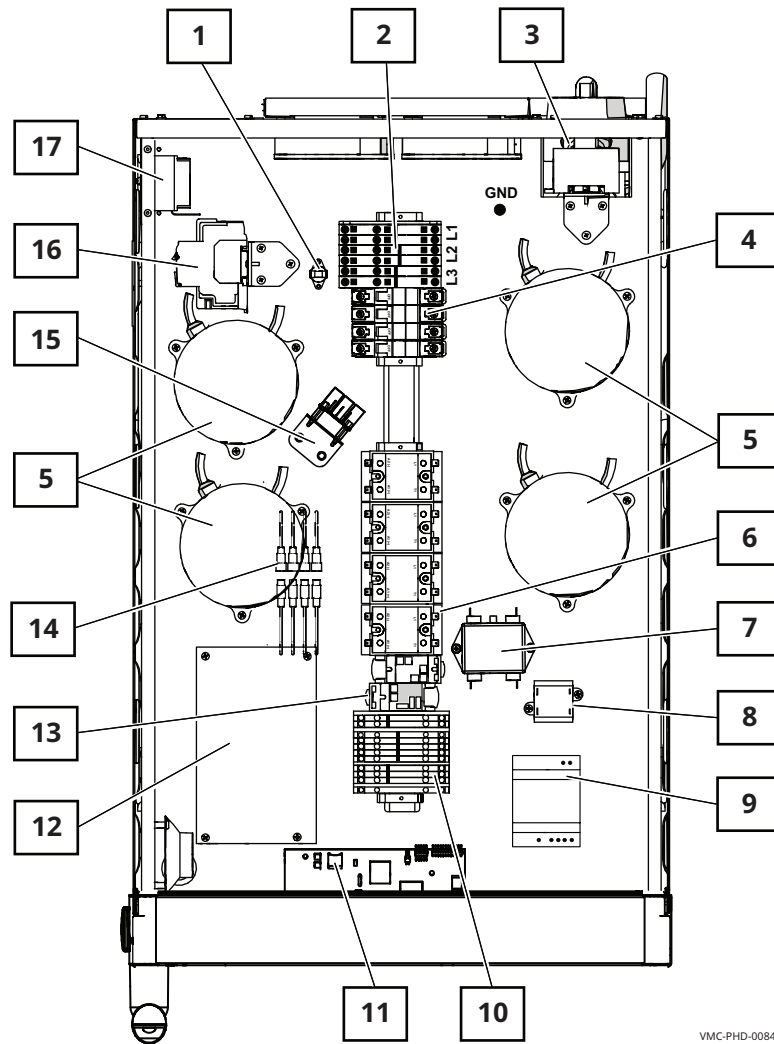

VMC-PHD-008460

Ref.	Description	Ref.	Description
1	Check fans indicator light switch	10	Terminal blocks
2	Terminal blocks	11	Interface board
3	Main disconnect switch	12	Control board
4	Circuit breakers (heating elements)	13	Relays
5	Variable Frequency Drive (VFD)	14	Fuses (lights)
6	Solid State Relay (SSR)	15	Wye filter (CE models only)
7	Line filter (CE models only)	16	Circuit breakers (control)
8	12VAC transformer	17	High limit switch(es)
9	12VDC power supply	—	—

H3—Electrical Component Identification

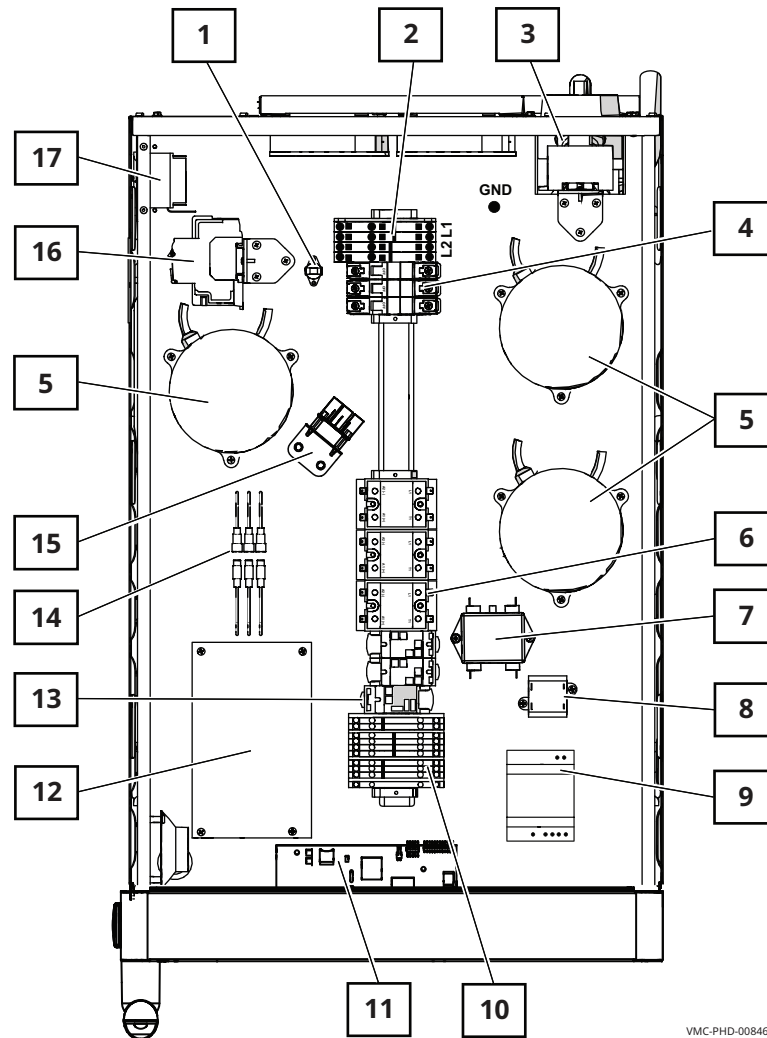

VMC-PHD-008463

Ref.	Description	Ref.	Description
1	Check fans indicator light switch	10	Terminal blocks
2	Terminal blocks	11	Interface board
3	Main disconnect switch	12	Control board
4	Circuit breakers (heating elements)	13	Relays
5	Variable Frequency Drive (VFD)	14	Fuses (lights)
6	Solid State Relay (SSR)	15	Wye filter (CE models only)
7	Line filter (CE models only)	16	Circuit breakers (control)
8	12VAC transformer	17	High limit switch
9	12VDC power supply	—	—

H2—Electrical Component Identification

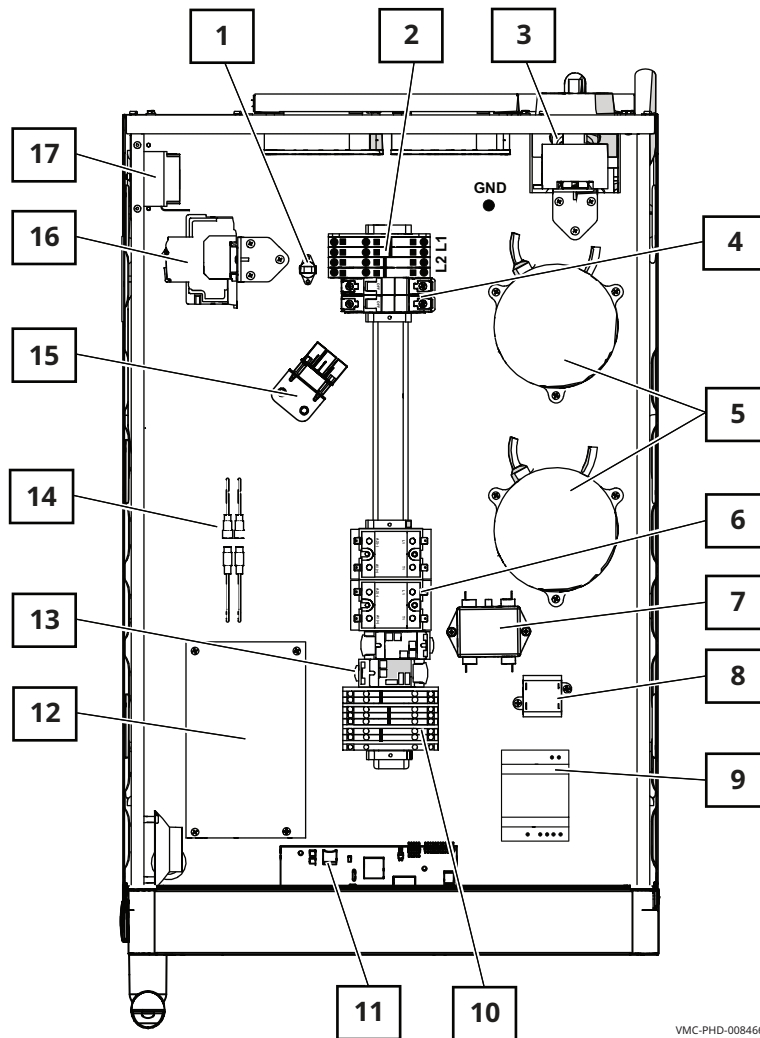

VMC-PHD-008466

Ref.	Description	Ref.	Description
1	Check fans indicator light switch	10	Terminal blocks
2	Terminal blocks	11	Interface board
3	Main disconnect switch	12	Control board
4	Circuit breakers (heating elements)	13	Relays
5	Variable Frequency Drive (VFD)	14	Fuses (lights)
6	Solid State Relay (SSR)	15	Wye filter (CE models only)
7	Line filter (CE models only)	16	Circuit breakers (control)
8	12VAC transformer	17	High limit switch
9	12VDC power supply	—	—

Electrical Components

Check Fans Indicator Light Switch

- The contacts close at or above 130°F (54°C)

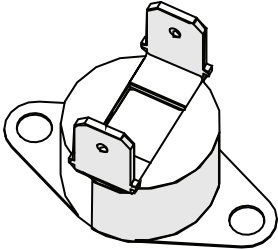

VMC-PHD-001903

Terminal Blocks for Electrical Supply

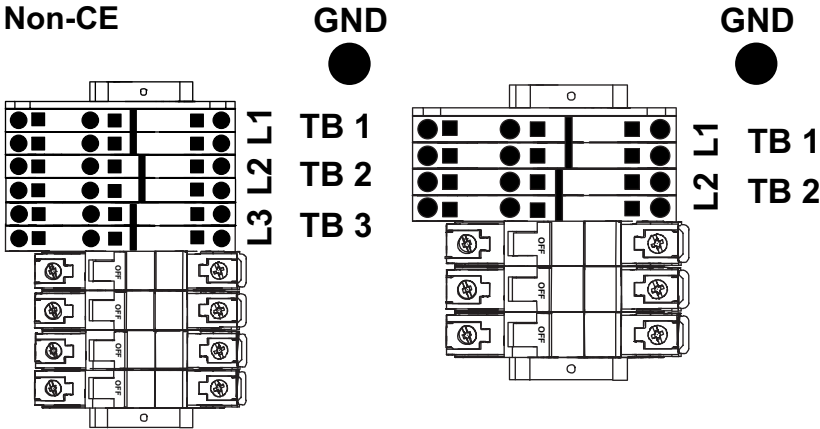

VMC-PHD-001907

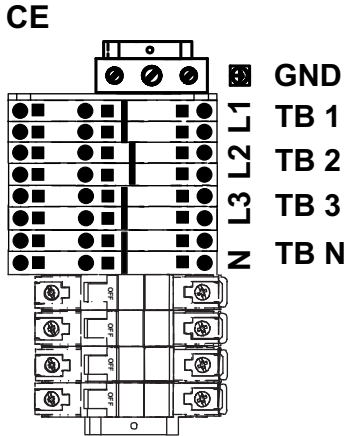

Main Disconnect Switch

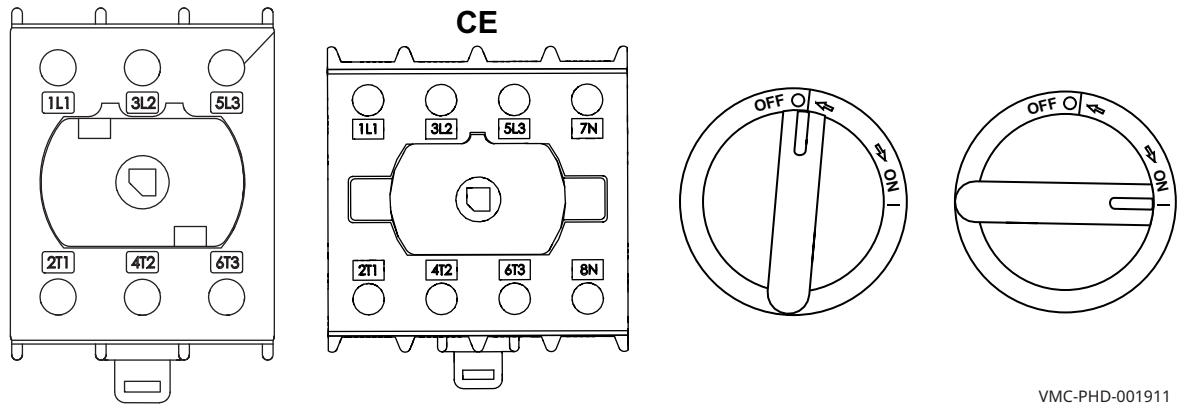

Circuit Breakers (Heating Elements)

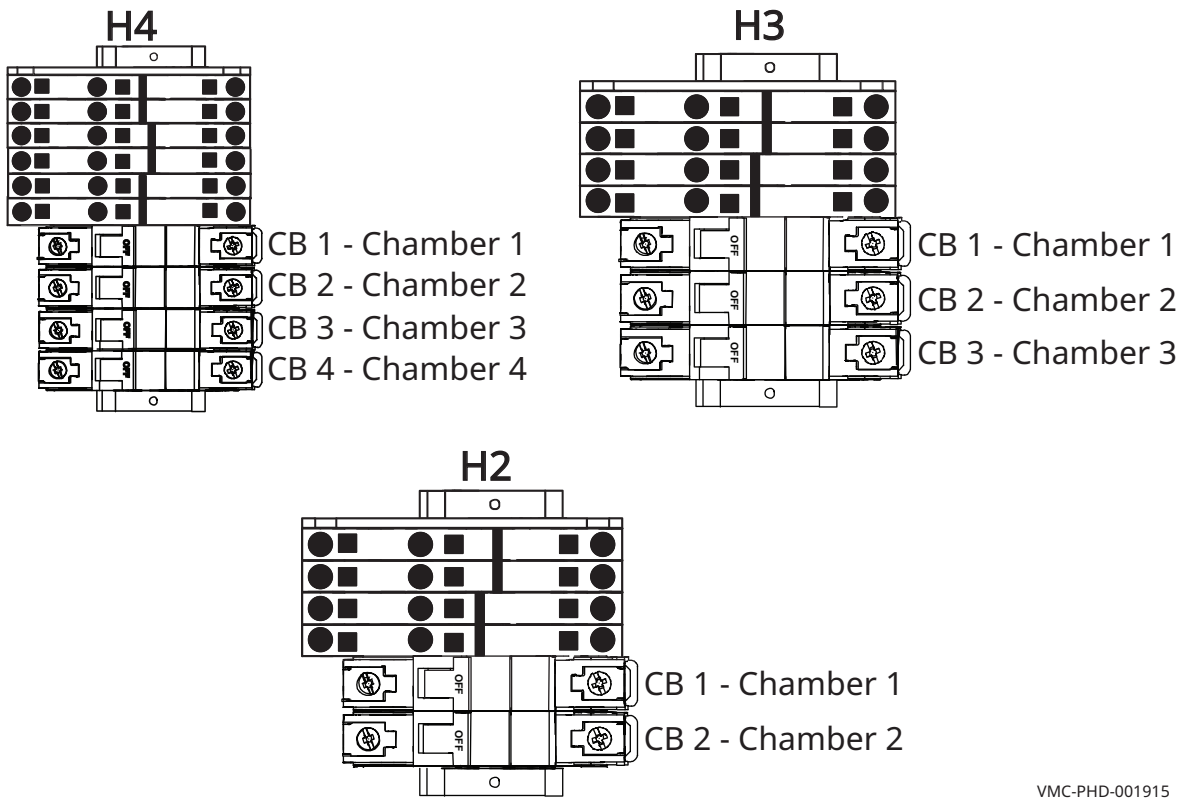

Variable Frequency Drive (VFD)

 **WARNING:** Electric shock hazard.
Do not disassemble the VFD.

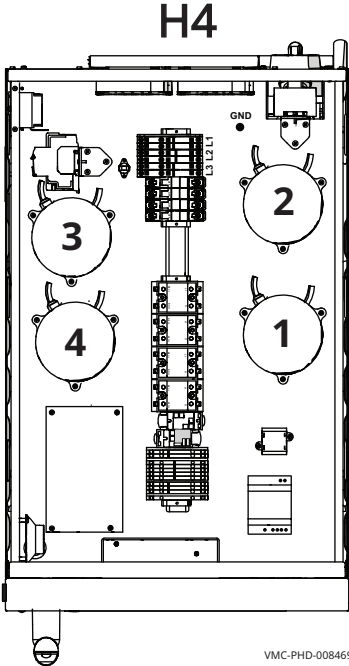
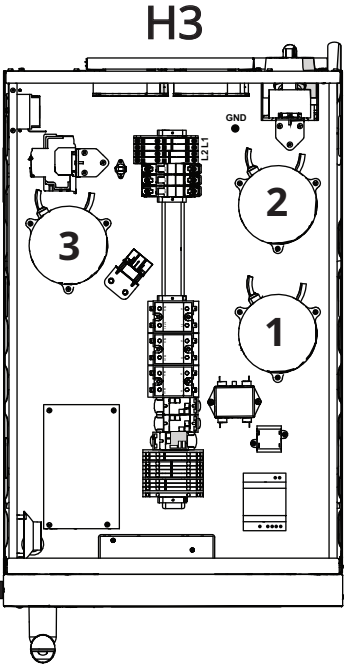
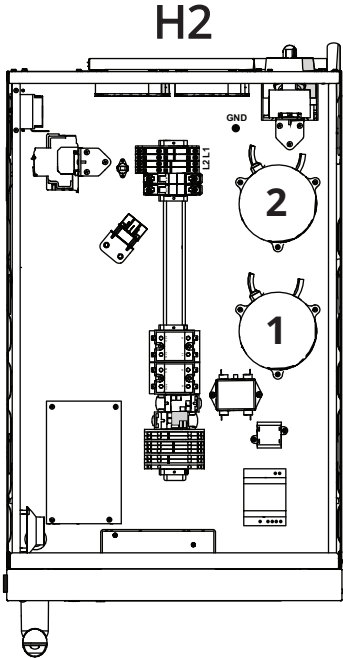
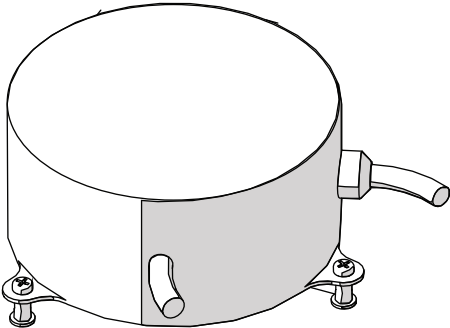

VMC-PHD-008469

Solid State Relay (SSR)

Heater element control. One SSR for each chamber.

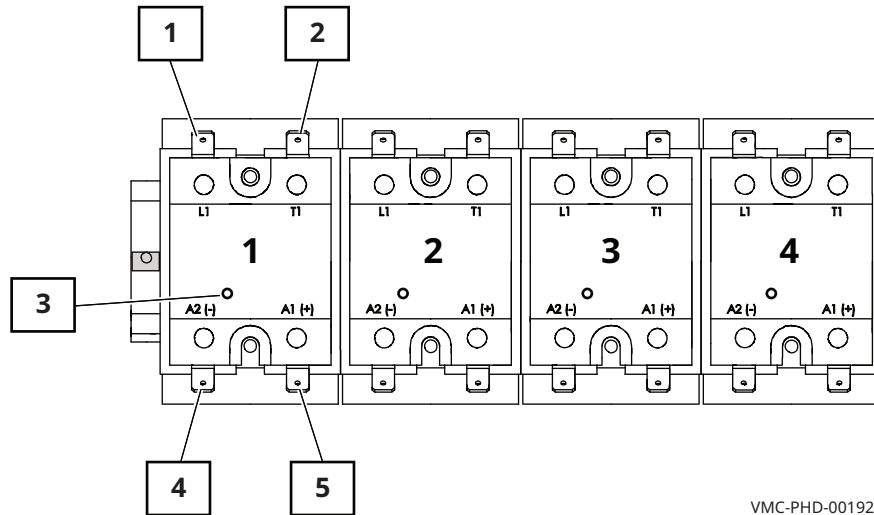

VMC-PHD-001923

Ref.	Description
1	L1 terminal, AC line voltage into the SSR
2	T1 terminal, AC load voltage to the heating element
3	Call for heat indicator light
4	A2 (-) terminal, DC control voltage from the control board to the SSR
5	A2 (+) terminal, DC control voltage from the control board to the SSR

Line Filter (CE only)

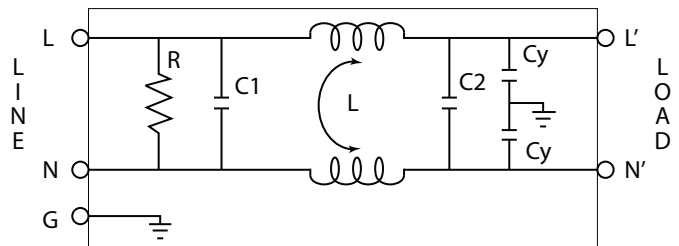
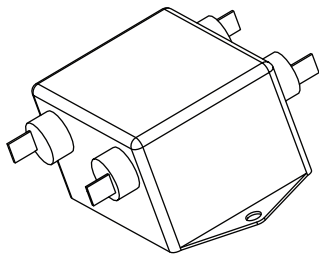

VMC-PHD-008472

12VAC Transformer

The transformer provides a voltage signal to the control board. The signal allows the control board to determine the incoming line voltage.

- Primary: 1700 Ohms
- Secondary: 6 Ohms

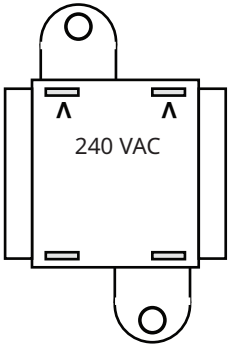

VMC-PHD-001927

12VDC Power Supply

Supplies DC voltage to the control board and the ON/OFF switch.

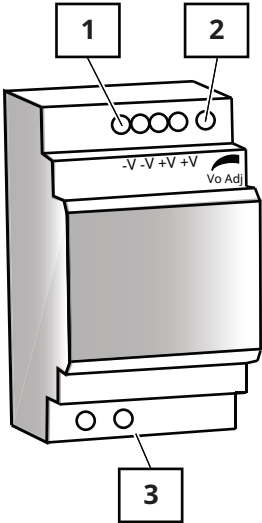

VMC-PHD-001935

Ref.	Description
1	12VDC terminals
2	12VDC adjustment
3	240VAC terminals

Terminal Blocks (VFDs and Cooling Fans)

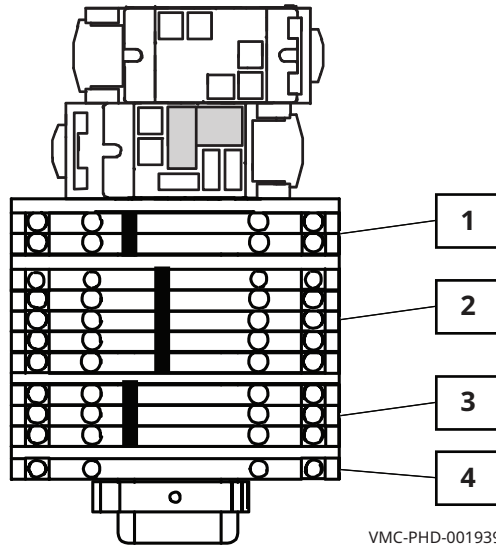

Ref.	Description
1	TB 4 - L2
2	TB 5 - L1
3	TB 6 - L2 (switched)
4	Ground

Interface Board

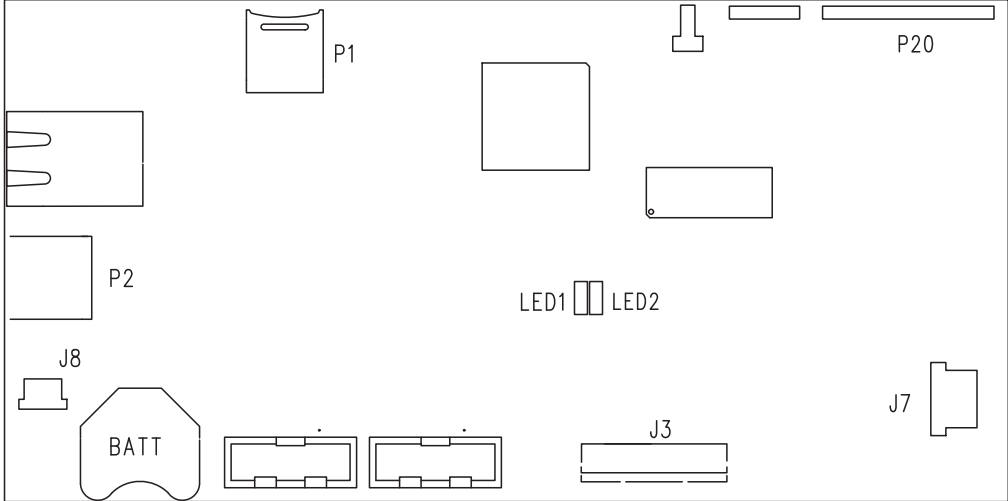

VMC-PHD-001943

Ref.	Description
BATT	Clock battery
J3	LCD display ribbon cable
J7	Control board communication
J8	Touch overlay ribbon cable
P1	4 GB micro SD card
P2	USB connection
P20	ON/OFF board
LED 1	RS485 communication
LED 2	RS485 communication

Control Board (CB)

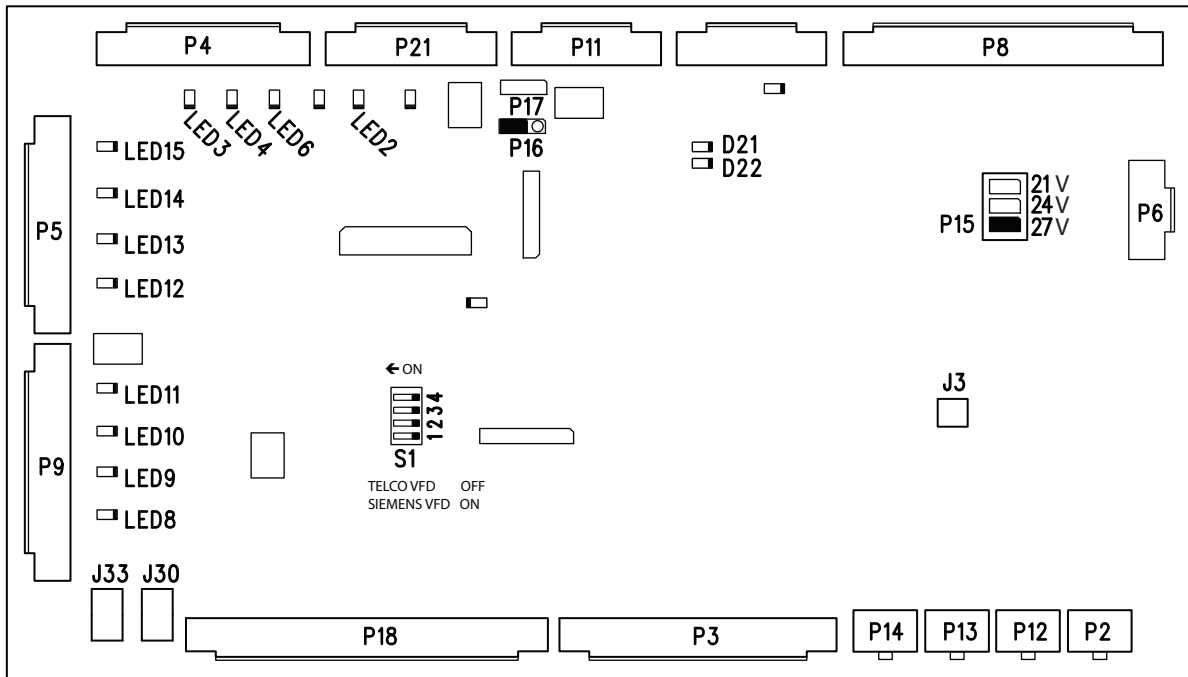

VMC-PHD-001947

Ref.	Description	Ref.	Description	Ref.	Description
P2	Drive 1 communication	P16	Jumper	LED 9	Chamber 2 call for heat
P3	Input signals	P17	Not used	LED 10	Chamber 3 call for heat
P4	Door handle lights (if equipped)	P18	Input from chamber combine switches (F Series only)	LED 11	Chamber 4 call for heat
P5	Lights	P21	Output to blower/fan relay RL1	LED 12	Chamber 1 light
P6	Input from 12VDC power supply	J3	Speaker	LED 13	Chamber 2 light
P8	Thermocouple inputs	J30	AC input from the transformer	LED 14	Chamber 3 light
P9	Heater control signal to SSRs	J33	AC input from the transformer	LED 15	Chamber 4 light
P11 or P10	Communication to UI board	LED 2	Cooling fan power	D21	RS485 communication
P12	Drive 2 communication	LED 3	Door handle lights (if equipped)	D22	RS485 communication
P13	Drive 3 communication	LED 4	Door handle lights (if equipped)	S1	Chamber VFD selection Telco VFD set to OFF Siemens VFD set to ON
P14	Drive 4 communication	LED 6	Door handle lights (if equipped)	—	—
P15	Jumper	LED 8	Chamber 1 call for heat	—	—

Relays

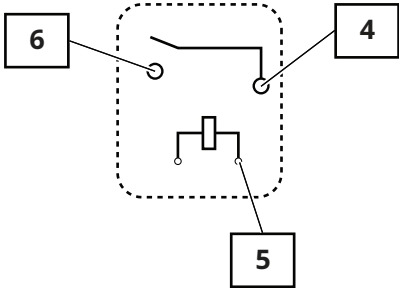
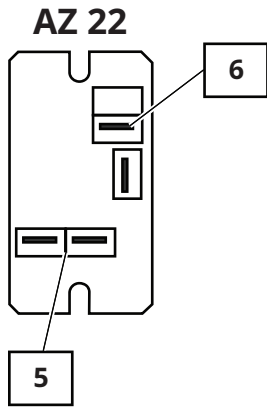
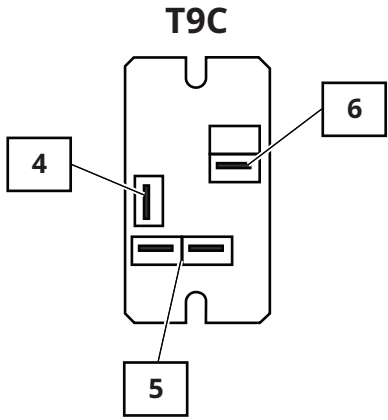
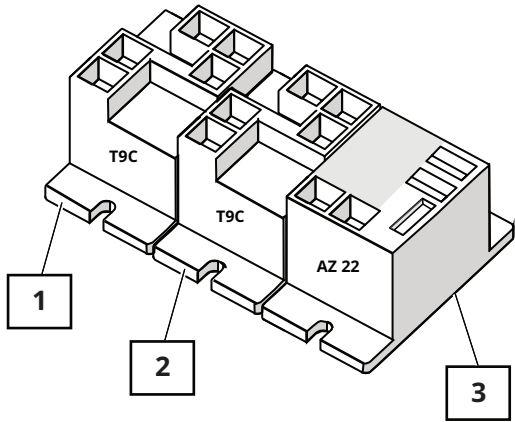

VMC-PHD-001951

Ref.	Description	Ref.	Description
1	RL-3 (H3 only)	4	Common terminal
2	RL-1, T9C, 240VAC coil Input to the control board for the check fan indicator light Coil—10.90 K Ohm	5	Coil terminal
3	RL-2, AZ 22, 12VDC coil Blowers/fan Coil—155 Ohm	6	Normally open terminal

Fuses (Chamber Lights)

Fuse, 1A, 250V, Slow-Blo, 5 x 20 mm

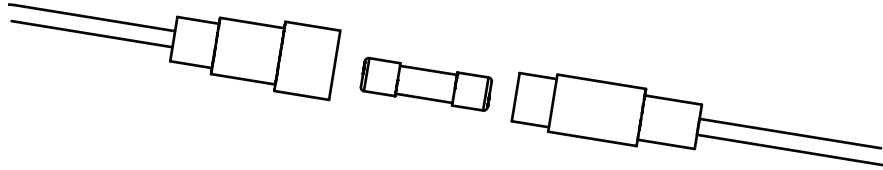

VMC-PHD-007561

Wye Filter (CE Models)

Capacitance range	0.1-10.0uF
Tolerance	±10%

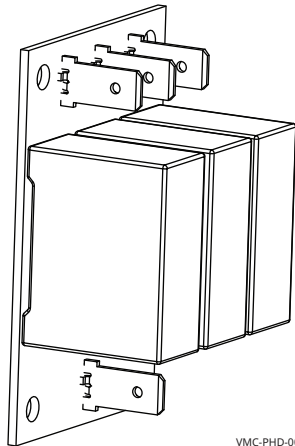

VMC-PHD-008475

Circuit Breakers (Control)

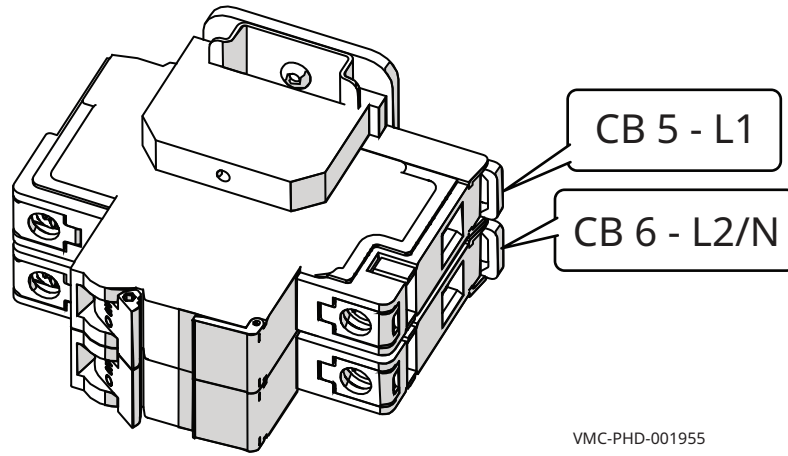

High Limit Switches

Resettable

Contacts open at 572°F (300°C)

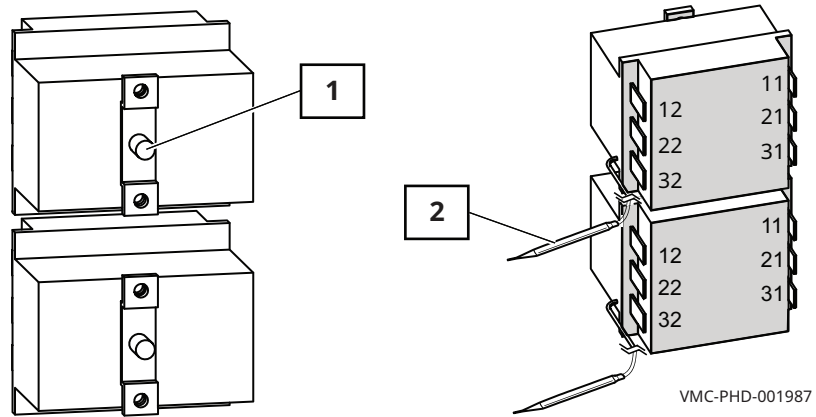

Ref.	Description
1	Reset button
2	Temperature bulb

Left Service Panel Identification

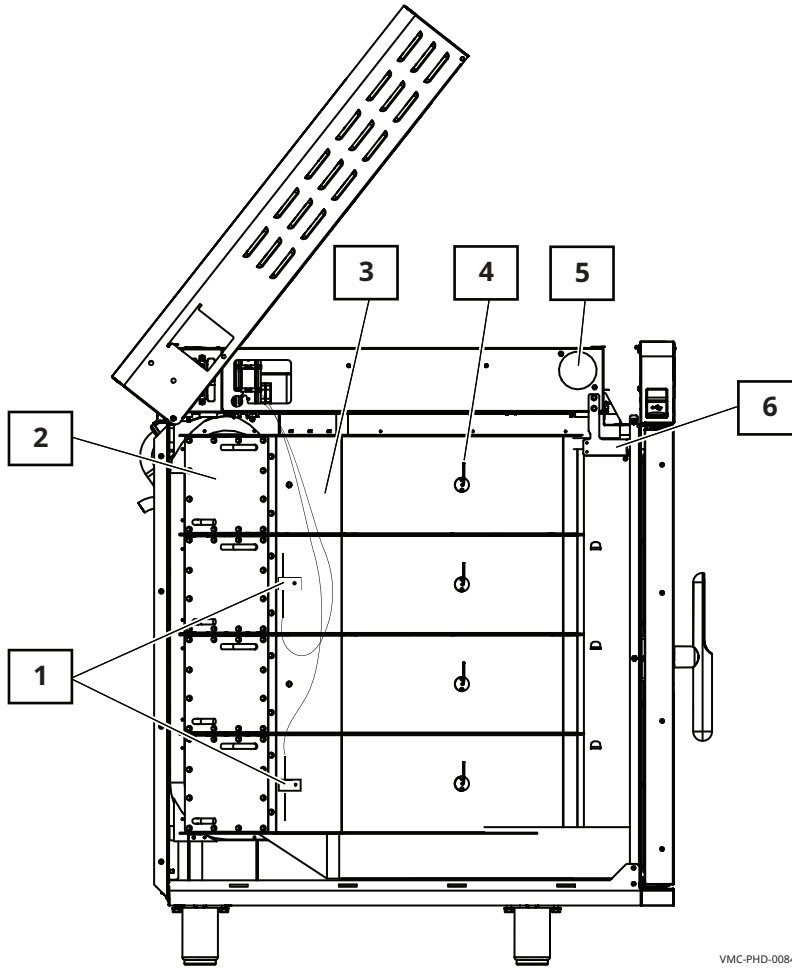

VMC-PHD-008478

Ref.	Description
1	High limit switch temperature bulbs
2	Chamber heating element
3	Catalyst
4	Chamber air temperature probes
5	Speaker
6	Door switch

Left Service Panel Components

Chamber Heating Element

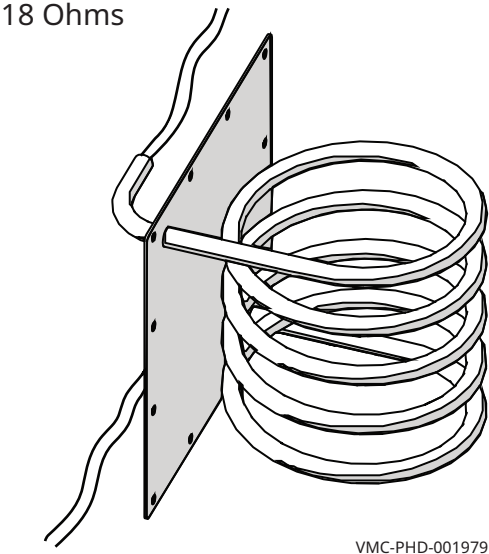

Catalyst

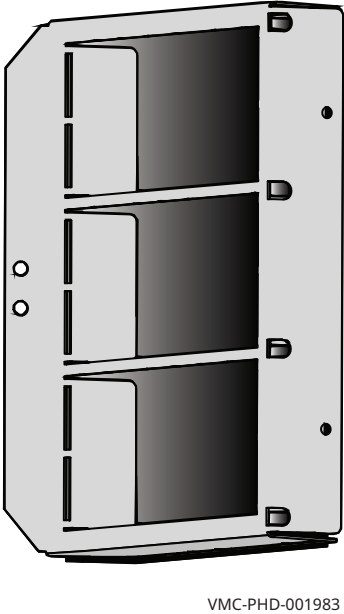

Chamber Air Temperature Probe

K Type Thermocouple

100°C	4.096 MV	100°F	1.521 MV
200°C	8.138 MV	200°F	3.820 MV
300°C	12.209 MV	300°F	6.094 MV

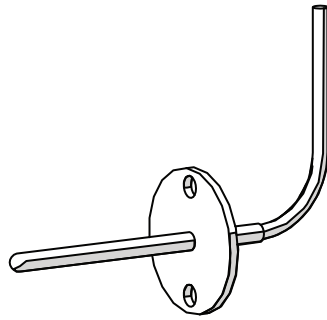

VMC-PHD-001991

Speaker

8 Ohms

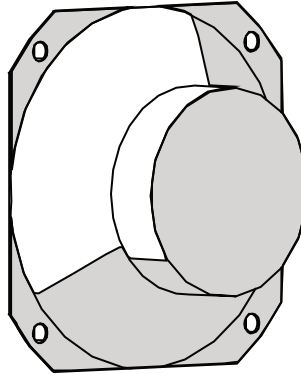

VMC-PHD-001995

Door Switch

- **Door closed** 0 Ohms; 0 VDC across terminals 1 and 2 of connector P3 on the control board.
- **Door open** Infinite Ohms; 8 VDC across terminals 1 and 2 of connector P3 on the control board.

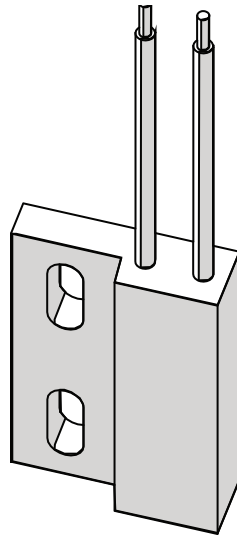

VMC-PHD-001999

Right Service Panel Identification

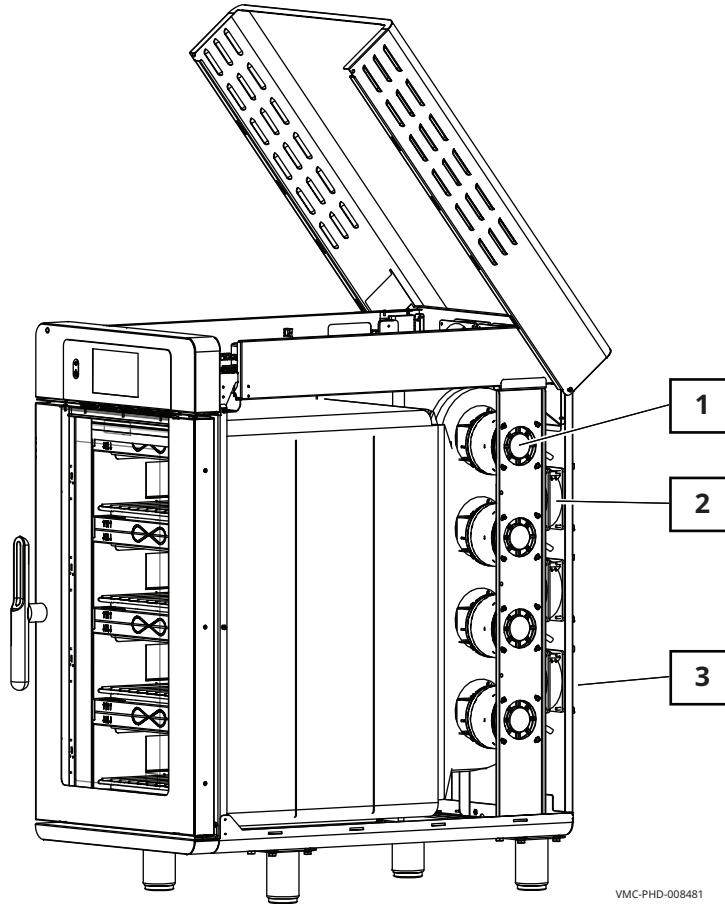

VMC-PHD-008481

Ref.	Description
1	Chamber blower motor
2	Cooling fans
3	Filter—cooling air

Right Service Panel Components

Blower Assembly

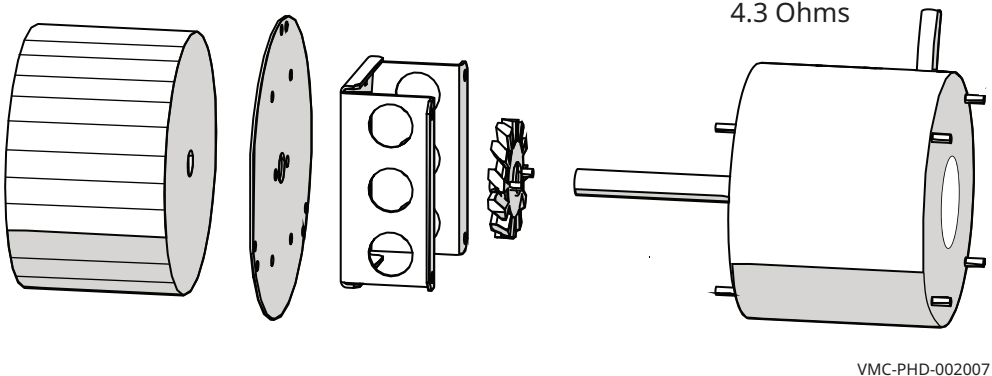

Fans

- Impedance protected
- 240 Volt
- 581 Ohm



Filter—Cooling Air

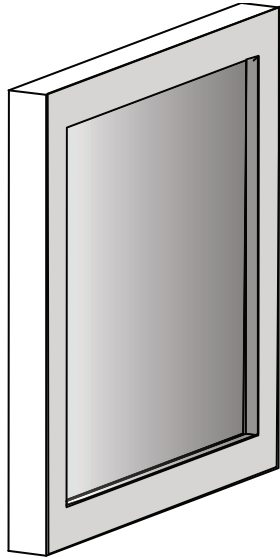

VMC-PHD-002015

Internal Components Identification

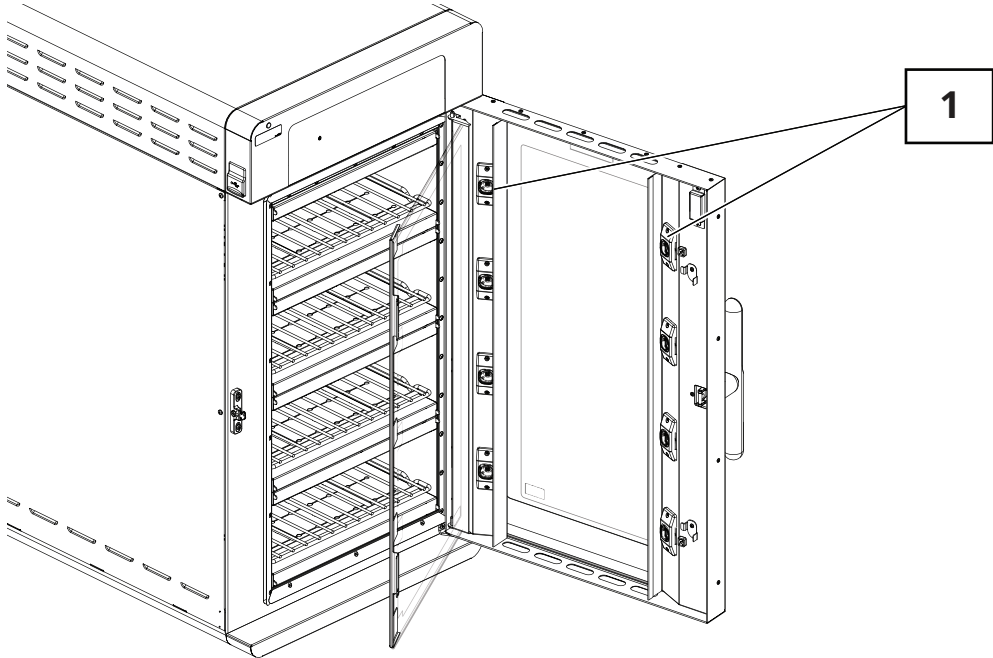

VMC-PHD-007583

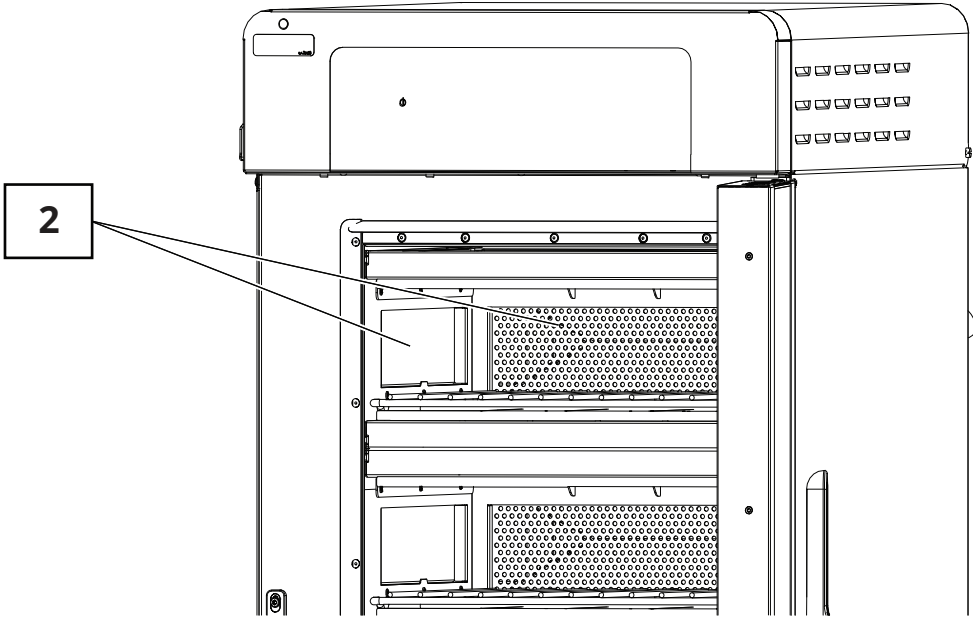

VMC-PHD-007580

Ref.	Description
1	Chamber light
2	Filters (optional)

Internal Components

Chamber Light

12 VDC

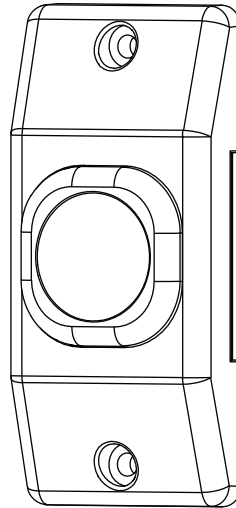

VMC-PHD-007587

Filters (optional)

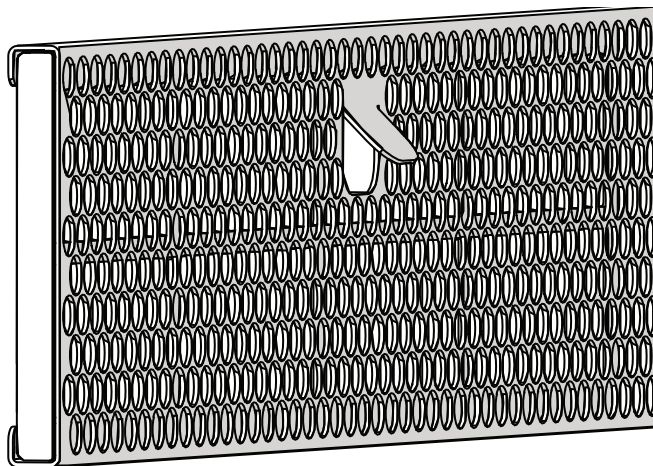

VMC-PHD-002027

Standby State

Background

The main disconnect switch is in the ON position, the display is not illuminated.



WARNING: Electric shock hazard.

Voltage is present at the following components:

- Terminal blocks
- Circuit breakers
- Heater elements, one wire on each element
- Check indicator light
- Thermal switch for the check fan indicator light
- Transformer
- Control board power supply
- Chamber high limit switches

Each chamber will transition to the cool down state if the chamber temperature is greater than 170°F (77°C).

Component	State
Control panel	OFF
LCD backlight	OFF
Heaters	OFF
Cooling fans	OFF
Blower	OFF
Buzzer / speaker	OFF

On State

Background

The main disconnect switch is in the ON position, the display is illuminated. The logo will appear along with the firmware versions on the display. After five seconds, the LCD will display the home screen.



WARNING: Electric shock hazard.

Voltage is present at the following components:

- Terminal blocks
- Circuit breakers
- Heater elements, one wire on each element
- Check indicator light
- Thermal switch for the check fan indicator light
- Transformer
- Control board power supply
- Chamber high limit switches

Component	State
Control panel	ON
LCD backlight	ON
Heaters	OFF
Cooling fans	OFF
Blower	OFF
Buzzer / speaker	OFF

Preheat State

Background

Pressing Preheat will automatically begin preheating all chambers up to their pre-programmed default temperature setpoints. It should take approximately 10-15 minutes for the oven to reach temperature.

The Temps icon in the User Configuration screen allows the user to change the individual chamber preheat temperatures.

The chamber blower fans are driven at 70% rotation speed by the VFDs.

Component	State
Control panel	Countdown
LCD backlight	ON
Heaters	ON
Cooling fans	ON
Blower	ON, at 70%
Buzzer / speaker	OFF

Idle State

Background

As each chamber reaches its temperature setpoint, it will start a 5-minute countdown to allow the chamber temperature to stabilize.

The chamber blower fans are driven at 30% rotation speed by the VFDs.

Component	State
Control panel	ON
LCD backlight	ON
Heaters	ON, maintaining the temperature setpoint requirements
Cooling fans	ON
Blower	ON, at 30%
Buzzer / speaker	OFF

Cooking State

Background

Each chamber is independently controlled. The current chamber is indicated by the check mark on the display. Opening the door will pause the cooking cycle. The oven will keep track of how long the door is open and automatically add time to any current cooking cycle to compensate for the temperature loss.

The chamber blower fans are driven at rotation speed by the VFDs to meet the requirements of the cook setting.

Component	State
Control panel	ON
LCD backlight	ON
Heaters	ON, maintaining the cooking temperature setpoint
Cooling fans	ON
Blower	ON, based on cook setting requirements, minimum 10%
Buzzer / speaker	OFF
Chamber light	User controlled

Cooking State Complete

Background

At the end of the cooking cycle, the oven buzzer/speaker sounds an alert and the chamber light flashes.

The chamber blower fans are driven at 30% rotation speed by the VFDs.

Component	State
Control panel	ON
LCD backlight	ON
Heaters	ON, maintaining the temperature setpoint
Cooling fans	ON
Blower	ON, at 30%
Buzzer / speaker	Beeps until the door is opened
Chamber light	Blinks until the door is opened

Rapid ON/OFF State

Background

Each chamber transitions to the rapid ON/OFF state if the chamber temperature is greater than 20°F (11°C) from the temperature setpoint.

The chamber blower fans are driven at 70% rotation speed by the VFDs.

Component	State
Control panel	ON
LCD backlight	ON
Heaters	ON, if chamber temperature is > 20°F (11°C) below the temperature setpoint OFF, if chamber temperature is > 20°F (11°C) above the temperature setpoint
Cooling fans	ON
Blower	ON, at 70%
Buzzer / speaker	OFF
Chamber light	Blinks until the door is opened

Cool Down State

Background

The oven automatically turns on the blowers for the cool down process.

With the oven door open, the oven takes approximately 2 hours to cool down to a chamber temperature of 140°F (60°C).

The screen displays a cool down prompt and requests for the door to be opened. The oven shuts down once the cool down is complete.

The chamber blower fans are driven at 50% rotation speed by the VFDs.

Component	State
Control panel	ON
LCD backlight	ON
Heaters	OFF
Cooling fans	ON
Blower	ON, at 50%
Buzzer / speaker	OFF

Cool Down State Complete

Background

The oven transitions to the OFF state after 20 minutes.

Component	State
Control panel	ON
LCD backlight	ON
Heaters	OFF
Cooling fans	OFF
Blower	OFF
Buzzer / speaker	OFF

This page intentionally left blank.

Maintenance Schedule

Requirements

- See topic *How to Clean the Oven*.
- Make sure the oven is cooled down and off—inside of chamber 140°F (60°C) or less.

Daily

For daily maintenance, do the following.

- **Remove** any spills with disposable paper wipes or a damp cloth.
- **Wipe** the outside of the oven with a damp cloth.
- **Check** the screen for cracking or peeling. Contact Technical Service if needed.

Weekly

For weekly maintenance, do the following.

- **Clean** the entire oven. **Make sure** to use a non-abrasive nylon scrub pad.
- Do not spray the cleaner directly into the fan openings located in the rear of the oven.

Monthly

For monthly maintenance, do the following.

- **Inspect** and clean the cooling fan filters.
- **Inspect** and clean the chamber filters (if equipped).

Yearly

For yearly maintenance, do the following.



NOTE: Must be performed by a qualified professional.

- **Check and tighten** all wire connections.
- **Inspect** the heater flange area for grease leakage.
- **Inspect** the motor flange area for grease leakage.
- **Check and tighten** all display, interface and control board connections.
- **Check and tighten** the door hinges.
- **Inspect** the inner and outer door window panes for cracking or chipping.
- **Test** each chamber fan for correct operation.
- **Test** each chamber heater for correct operation.
- **Test** the chamber lights.
- **Record** the software versions and update if necessary.
- **Inspect** the door gaskets for correct shape and seal.
- **Record** the amp draw of all elements on the service screen individually.
- **Record** the incoming supply line voltage.

How to Clean the Oven

Before you begin



WARNING: Electric shock hazard.
Set the main disconnect switch to the OFF position to remove electric power from the appliance.



CAUTION: Burn hazard.
Allow the oven, utensils, and racks to cool before cleaning.



CAUTION: Corrosive materials hazard.
Wear eye protection and hand protection when cleaning.

NOTICE

Using improper cleaning procedures will damage the catalyst and void the warranty.
Only use spray cleaner when the electric power is completely removed from the oven.
Do not spray water or cleaning solution on the catalyst.
Do not spray cleaner into the oven while the recirculation blower is running.
Do not use steel pads, wire brushes, or scrapers when cleaning.

Daily cleaning procedure

To clean the oven daily, do the following.

Step	Action
1.	Make sure the oven is turned off and cool—chambers are less than 140°F (60°C).
2.	Remove any spills with disposable paper wipes or a damp cloth.
3.	Wipe the outside of the oven with a damp cloth.
4.	Wipe the outside of the oven with a stainless steel cleaner.

Continued on next page

Continued from previous page

Weekly cleaning procedure

To clean the oven weekly, do the following.

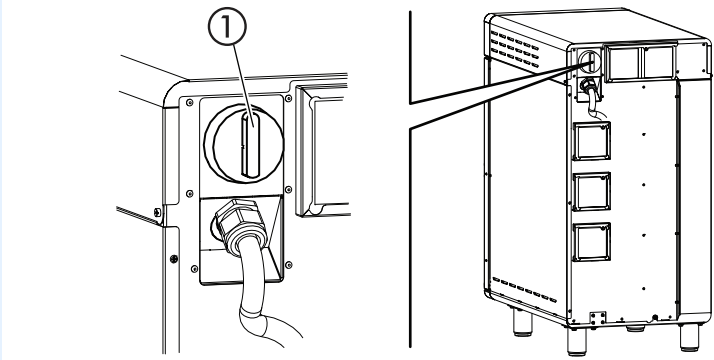
Step	Action
1.	<p>Set the main disconnect switch ① to the OFF position. Make sure the oven is cool—chambers are less than 140°F (60°C).</p>  <p style="text-align: right; font-size: small;">VMC-TS-006236</p>
2.	<p>Spray the exterior areas of the oven with stainless steel polish.</p> <div style="border: 1px solid blue; padding: 5px; margin-top: 10px;"> <p>NOTICE Use only non-caustic cleaners. Do not spray directly into the fan openings on the rear of the oven. Do not use cleaners that contain sodium hydroxide (lye) or phosphorus.</p> </div>
3.	Wipe the exterior areas of the oven with a non-abrasive nylon scrub pad.
4.	Spray the interior areas of the oven with EcoLab Greaselift™ or Chemco Dirt Buster III™ oven cleaner. Let the cleaner work for 3-5 minutes.
5.	Wipe the interior of the oven with a non-abrasive nylon scrub pad.
6.	Clean each side of the window pane with an all-purpose cleaner.
7.	Set the main disconnect switch ① to the ON position when complete.

Continued on next page

Continued from previous page

Monthly cleaning procedure

To clean the oven monthly, do the following.

Step	Action
1.	Set the main disconnect switch to the OFF position. Make sure the oven is cool—chambers are less than 140°F (60°C).
2.	Remove the cooking racks ① and jet plates ②. <div data-bbox="662 531 753 615" data-label="Image"> </div> CAUTION: Personal injury hazard. Use hand protection when handling the jet plates.
<div data-bbox="587 640 1432 1283" data-label="Image"> </div>	
3.	Separate the jet plates. Flexing the jet plates outward can aid in separating the jet plates.
4.	Spray the jet plates with EcoLab Greaselift™ or Chemco Dirt Buster III™ ③ oven cleaner. Let the cleaner work for 3–5 minutes. Follow safety instructions on cleaner bottle.
5.	Scrub the jet plates with a non-abrasive nylon scrub pad. Rinse the jet plates with water.
6.	Spray a towel with EcoLab Greaselift™ or Chemco Dirt Buster III™ then wipe the inside of the oven. Remove any residue with a water-soaked towel.
7.	Clean the door glass ④ with Windex® or equivalent glass cleaner.

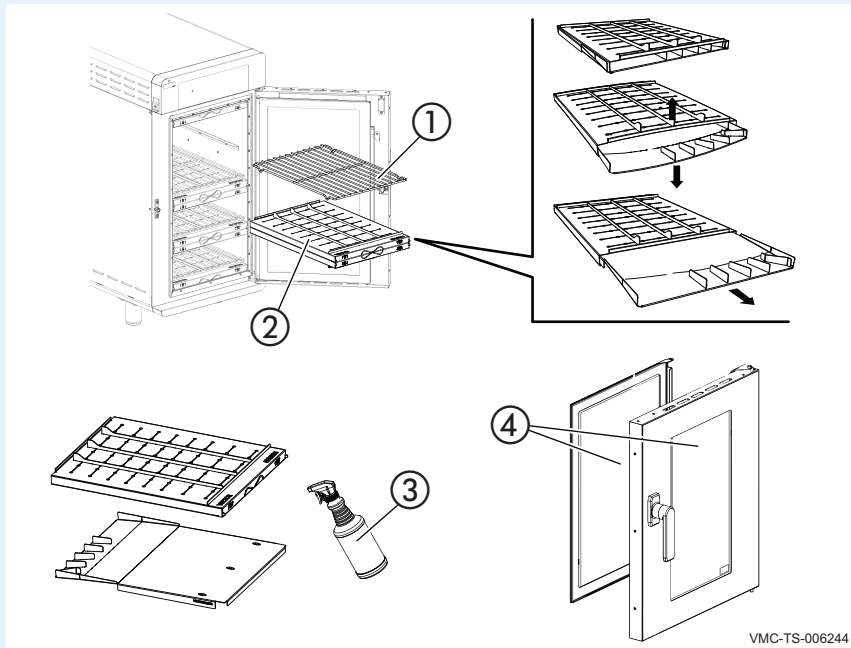

VMC-TS-006244

Continued on next page

Continued from previous page

8. **Re-install** the jet plates and cooking racks.

i **NOTE:** Make sure the jet plates are installed correctly. The nozzles on the jet plates should be pointing towards the food.

**Cleaning the filters
(if equipped)**

9. **Remove** the filters **5**.

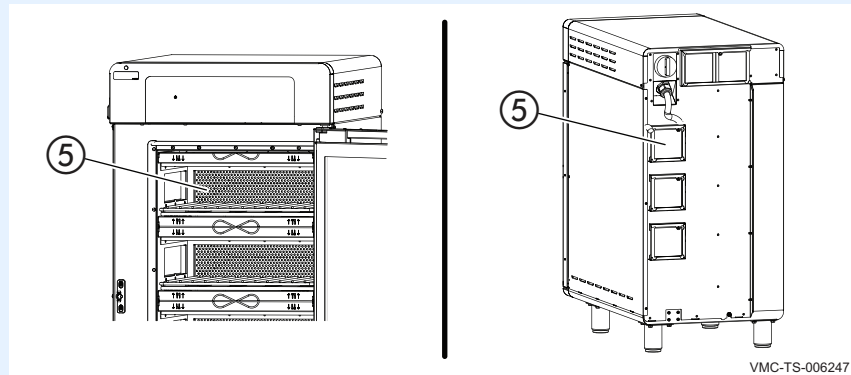

10. **Spray** the filters with a mild cleaner and rinse with hot water.

i **NOTE:** Replace the filters at least once a year.

11. **Re-install** the filters.

12. **Set** the main disconnect switch to the ON position when complete.

Result

The oven is now clean.

This page intentionally left blank.

How to Test the Cooling Fans

Before you begin

- The oven must be connected to electric power.
- Make sure the chamber's are in an OFF state.
- Make sure the top cover and side panels are installed when testing the cooling fans.

Procedure

To test the cooling fans, do the following.

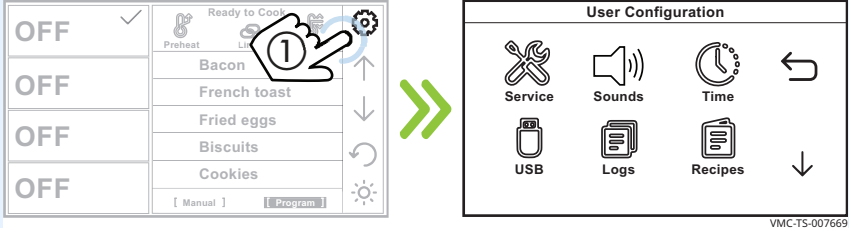
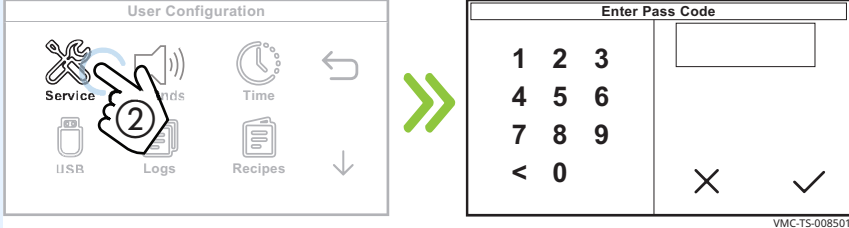
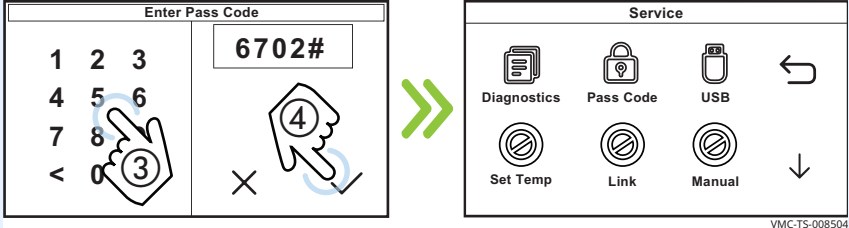
Step	Action
1.	<p>Touch the gear icon ①. The User Configuration screen displays.</p>  <p style="text-align: right; font-size: small;">VMC-TS-007669</p>
2.	<p>Touch the Service icon ②. The Enter Pass Code screen displays.</p>  <p style="text-align: right; font-size: small;">VMC-TS-008501</p>
3.	<p>Enter the pass code 6702 ③.</p> <p>Touch the green check mark ④. The first Service screen displays.</p>  <p style="text-align: right; font-size: small;">VMC-TS-008504</p>

Continued on next page

Continued from previous page

4. **Touch** the down arrow ⑤. The second Service screen displays.



5. **Touch** the Fans icon ⑥. The Cooling Fans screen displays.

Touch Touch here to turn fans ON or OFF ⑦ to turn on and turn off the cooling fans. See topic *The Cooling Fan(s) are Inoperable* if the coolings fans do not turn on.

Touch the return icon ⑧ to stop the cooling fans and return to the home screen.

NOTE: Touching the cancel icon will also stop the cooling fans and return to the "Service" screen.

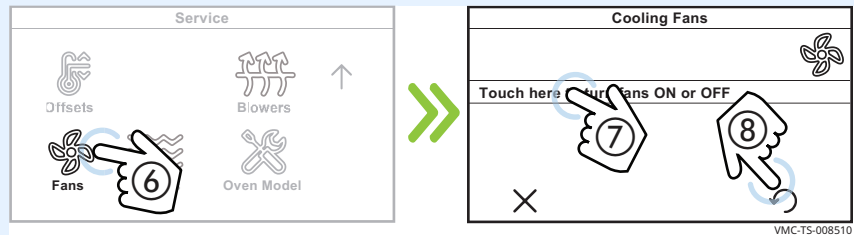

Result

The cooling fans have now been tested.

How to Test the Blower Motors

Before you begin

- The oven must be connected to electric power.
- Make sure the chamber's are in an OFF state.

Procedure

To test the blower motors, do the following.

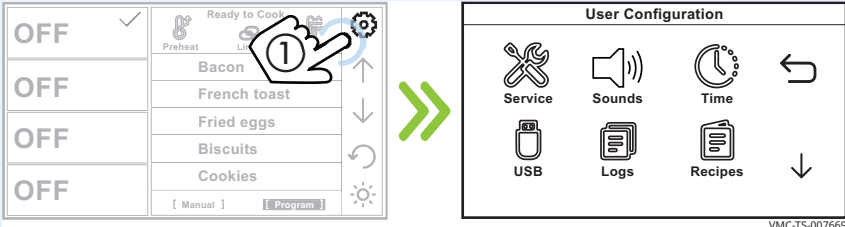
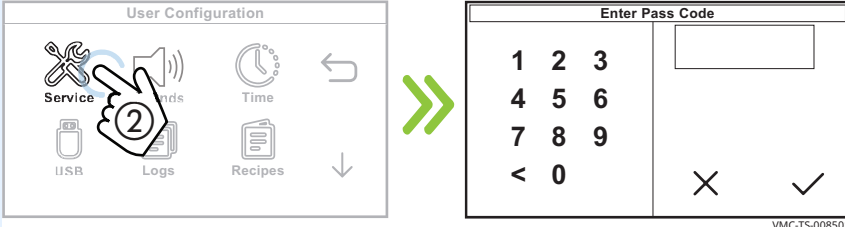
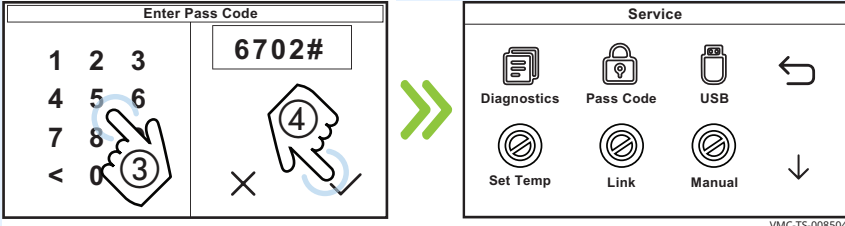
Step	Action
1.	<p>Touch the gear icon ①. The User Configuration screen displays.</p>  <p>The 'User Configuration' screen displays the following options: Service, Sounds, Time, USB, Logs, and Recipes.</p> <p>VMC-TS-007669</p>
2.	<p>Touch the Service icon ②. The Enter Pass Code screen displays.</p>  <p>The 'Enter Pass Code' screen displays a numeric keypad and a pass code input field.</p> <p>VMC-TS-008501</p>
3.	<p>Enter the pass code 6702 ③.</p> <p>Touch the green check mark ④. The first Service screen displays.</p>  <p>The 'Service' screen displays the following options: Diagnostics, Pass Code, USB, Set Temp, Link, and Manual.</p> <p>VMC-TS-008504</p>

Continued on next page

Continued from previous page

4. **Touch** the down arrow ⑤. The second Service screen displays.



VMC-TS-008507

5. **Touch** the Blowers icon ⑥. The Air Speed screen displays.

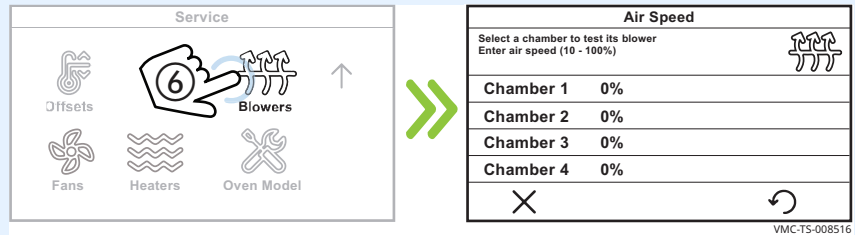

VMC-TS-008516

6. **Touch** the chamber ⑦ you want to test. The Enter Air Speed (10%-100%) screen displays.
Enter the air speed ⑧ using the number pad. **Touch** the green check mark ⑨.

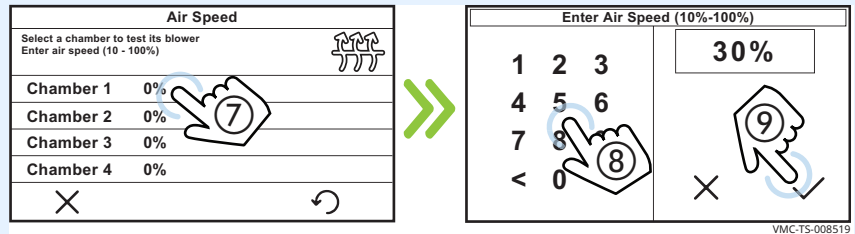

VMC-TS-008519

7. **Touch** the blower motor ⑩ and feel for vibration. See topic *Chamber Blower Fans Inoperable* if the blower motor does not turn on.

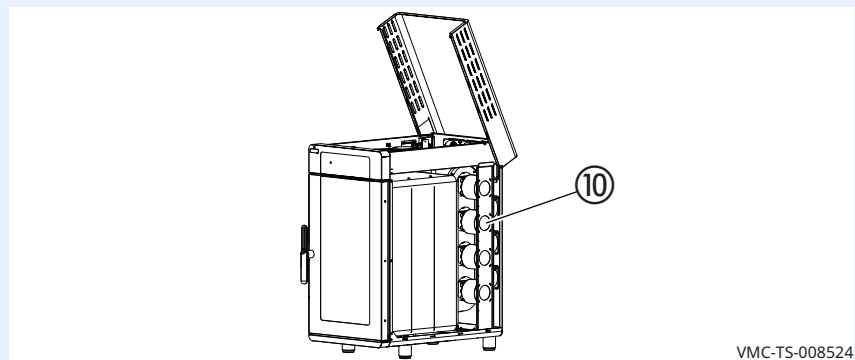

VMC-TS-008524

Continued on next page

Continued from previous page

8. **Touch** the return icon  to stop the blower motors and return to the home screen.

 **NOTE:** Touching the cancel icon will also stop the blower motors and return to the Service screen.

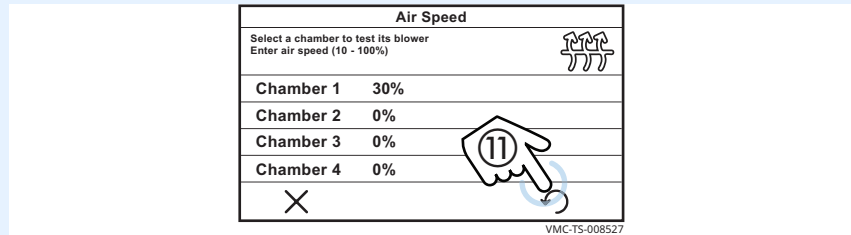

Result

The blower motors have now been tested.

How to Test the Heaters

Before you begin

- The oven must be connected to electric power.
- Make sure the chambers are in an OFF state.

Procedure

To test the heaters, do the following.

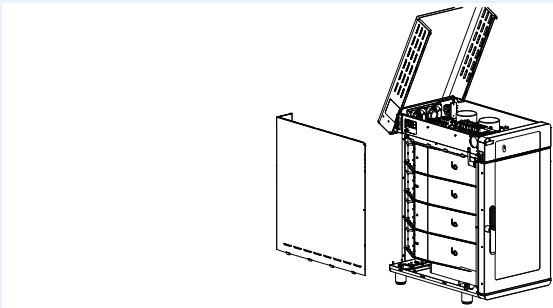
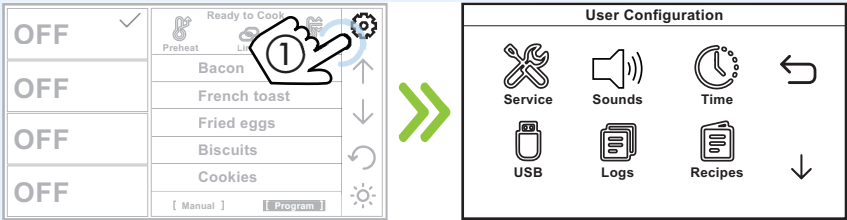
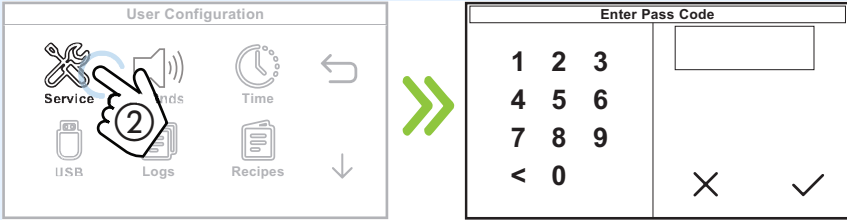
Step	Action
1.	<p>Remove the left side service panel.</p>  <p style="text-align: right;">VMC-TS-008535</p>
2.	<p>Touch the gear icon ①. The User Configuration screen displays.</p>  <p style="text-align: right;">VMC-TS-007669</p>
3.	<p>Touch the Service icon ②. The Enter Pass Code screen displays.</p>  <p style="text-align: right;">VMC-TS-008501</p>

Continued on next page

Continued from previous page

4. **Enter** the pass code 6702 (3).
Touch the green check mark (4). The first Service screen displays.

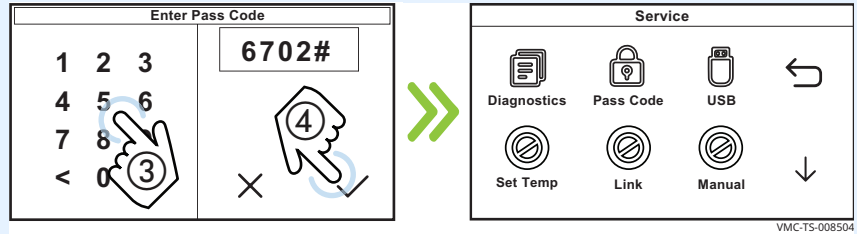

VMC-TS-008504

5. **Touch** the down arrow (5). The second Service screen displays.

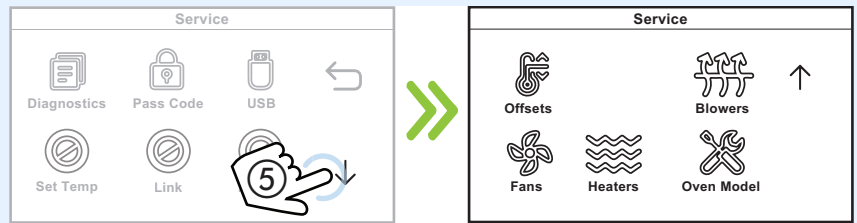

VMC-TS-008507

6. **Touch** the Heaters icon (6). The Heaters screen displays.

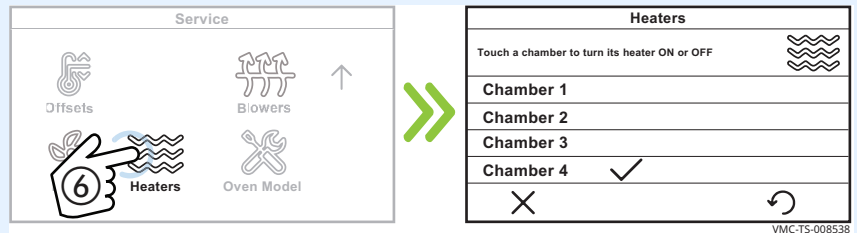

VMC-TS-008538

7. **Touch** the chamber (7) you want to test. A check mark indicates that chamber's heater is on.

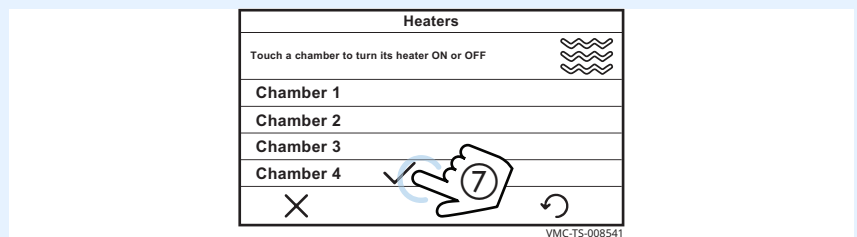

VMC-TS-008541

Continued on next page

Continued from previous page

8. **Measure** the amp draw while the heater is on. The amperage draw of a functioning heater element is 10–15 amps.



WARNING: Electric shock hazard.
Use caution when testing line voltage.

The heater will automatically stop after one minute of operation. See topic *The Chambers will not Heat* if the heaters do not turn on.

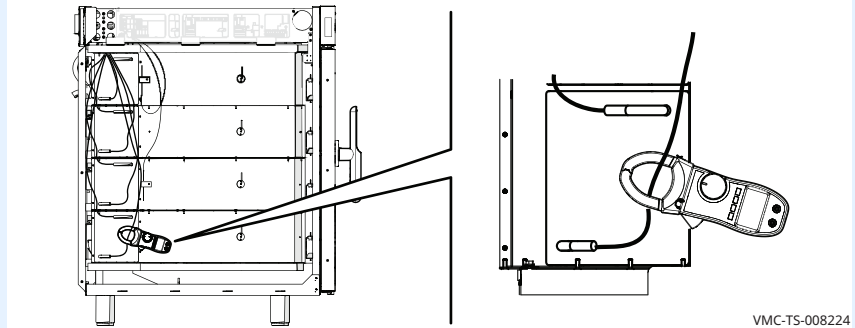

VMC-TS-008224

9. **Touch** the return icon (8) to stop the heaters and return to the home screen.



NOTE: Touching the cancel icon will also stop the heaters and return to the Service screen.

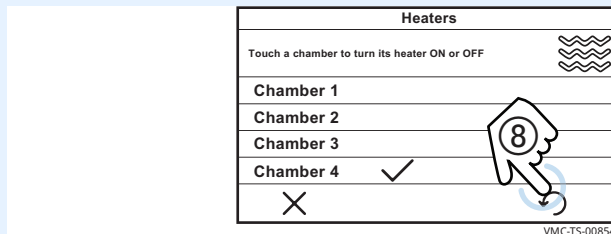

VMC-TS-008544

10. **Re-install** the side service panel.

Result

The heaters have now been tested.

How to Calibrate a Chamber Thermocouple

Before you begin

- The oven must be connected to electric power.
- Make sure the chamber's are in an OFF state.
- Make sure you have a multimeter with thermocouple attachment.
- Make sure the jet plates are installed.
- You will need to know the service pass code.

Procedure

To calibrate a chamber thermocouple, do the following.

Step	Action
------	--------

- | | |
|----|---|
| 1. | Insert the multimeter's thermocouple into the chamber corresponding to the oven thermocouple that needs calibrating. |
|----|---|

- | | |
|----|---|
| 2. | <p>Touch the chamber icon ①.</p> <p>Touch the Set Temp icon ②. The Enter Temperature screen displays.</p> <p>Enter a temperature of 450°F (232°C) ③ using the number pad.</p> <p>Touch the green check mark ④. The oven starts the preheat process.</p> |
|----|---|

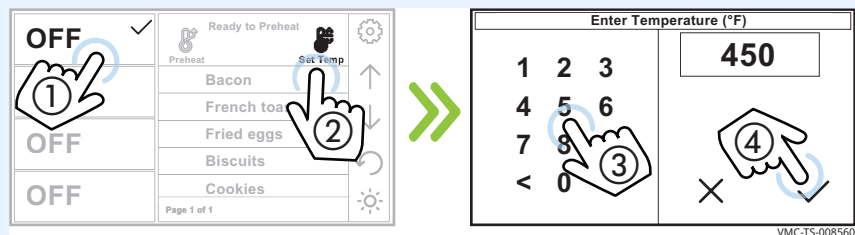

- | | |
|----|---|
| 3. | <p>Record the following after the oven has finished preheating:</p> <ul style="list-style-type: none"> ■ Temperature of the selected chamber. ■ Temperature from the multimeter. |
|----|---|

- | | |
|----|---|
| 4. | Touch the gear icon ⑤. The User Configuration screen displays. |
|----|---|

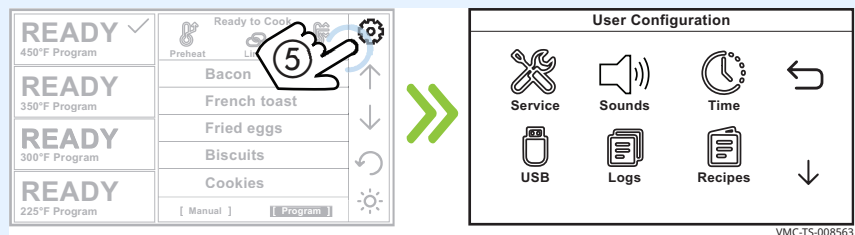

Continued on next page

Continued from previous page

5. **Touch** the Service icon (6). The Enter Pass Code screen displays.

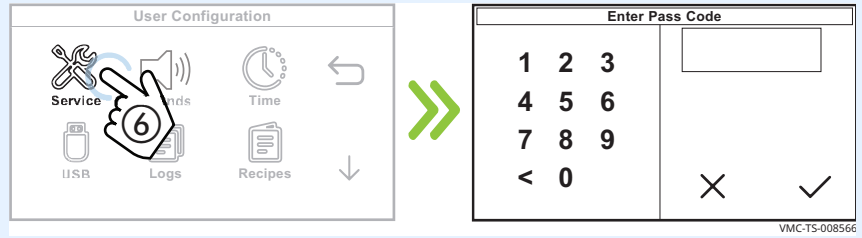

6. **Enter** the pass code (7).
Touch the green check mark (8). The first Service screen displays.

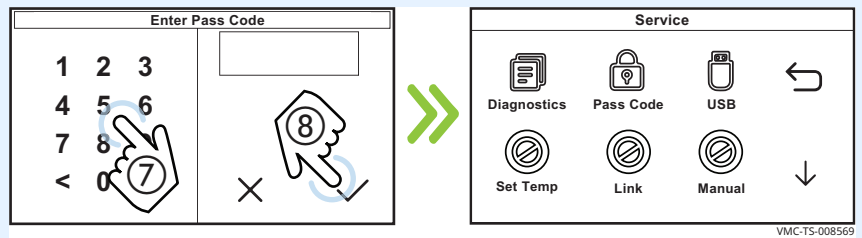

7. **Touch** the down arrow (9). The second Service screen displays.



8. **Touch** the Offsets icon (10). The Offsets screen displays.

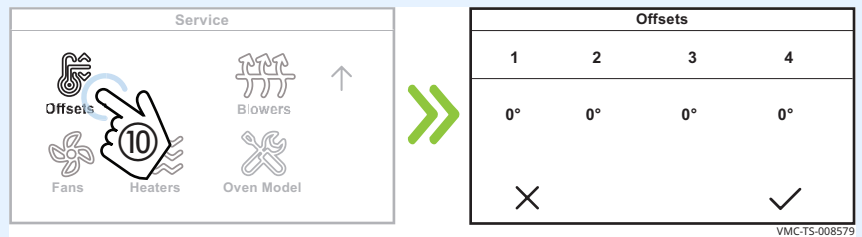

Continued on next page

Continued from previous page

9. **Touch** the chamber that needs to be calibrated (11). The Enter Offsets screen displays.

Enter the offset number (12) from the calculation.

To determine the offset number, subtract the smaller number from the larger number. If the multimeter number is larger, add a "+" in front of the resulting number. If the chamber number is larger, add a "-" in front of the resulting number.

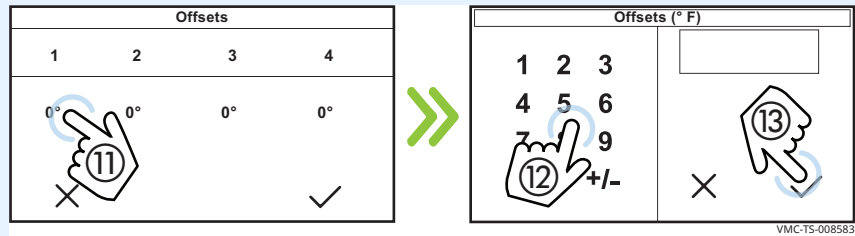

Touch the green check mark (13).

10. **Touch** the check mark (14) when finished.

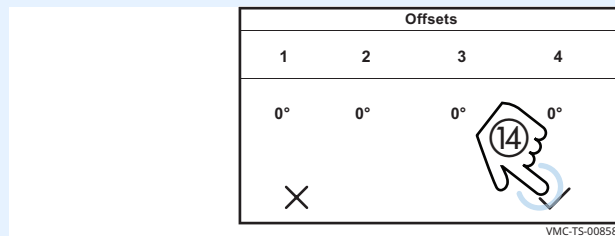

Result

The chamber thermocouple has now been calibrated.

This page intentionally left blank.

Error Messages

Background

This section is provided for the assistance of qualified and trained service technicians only and is not intended for use by untrained or unauthorized service personnel. Failure to observe this precaution may void the warranty.

Message	Meaning	Action required
ERR: HIGH LIMIT 1	The high limit 1 circuit is open to the control board. A message is also displayed on the screen.	Reset high limit 1. Reset the circuit breakers. Inspect the wires for the high limit 1 circuit input to the control board.
CLR: HIGH LIMIT 1	The high limit 1 error has been cleared.	—
ERR: HIGH LIMIT 2	The high limit 2 circuit is open to the control board. A message is also displayed on the screen.	Reset high limit 2. Reset the circuit breakers. Inspect the wires for the high limit 2 circuit input to the control board.
CLR: HIGH LIMIT 2	The high limit 2 error has been cleared.	—
ERR: ZC	Zero crossing error.	No action required. This error will automatically clear.
CLR: ZC	The zero crossing error has been cleared.	—

The Oven will not Power Up

Before you begin

- Move the main disconnect switch on the back of the oven to the OFF position.
- Remove the circuit breaker service panel on the left side of the oven.
- Move the circuit breakers to the OFF position, then move the circuit breakers to the ON position.
- Move the main disconnect switch on the back of the oven to the ON position.
- The stripe screen should flash on the control panel and go blank.
- Press the ON/OFF button, the LED should illuminate.
- If the oven still does not power up, follow the troubleshooting procedure below.



WARNING: Electric shock and arc flash hazard.
Use caution when measuring line voltage.
Wear Personal Protective Equipment (PPE).

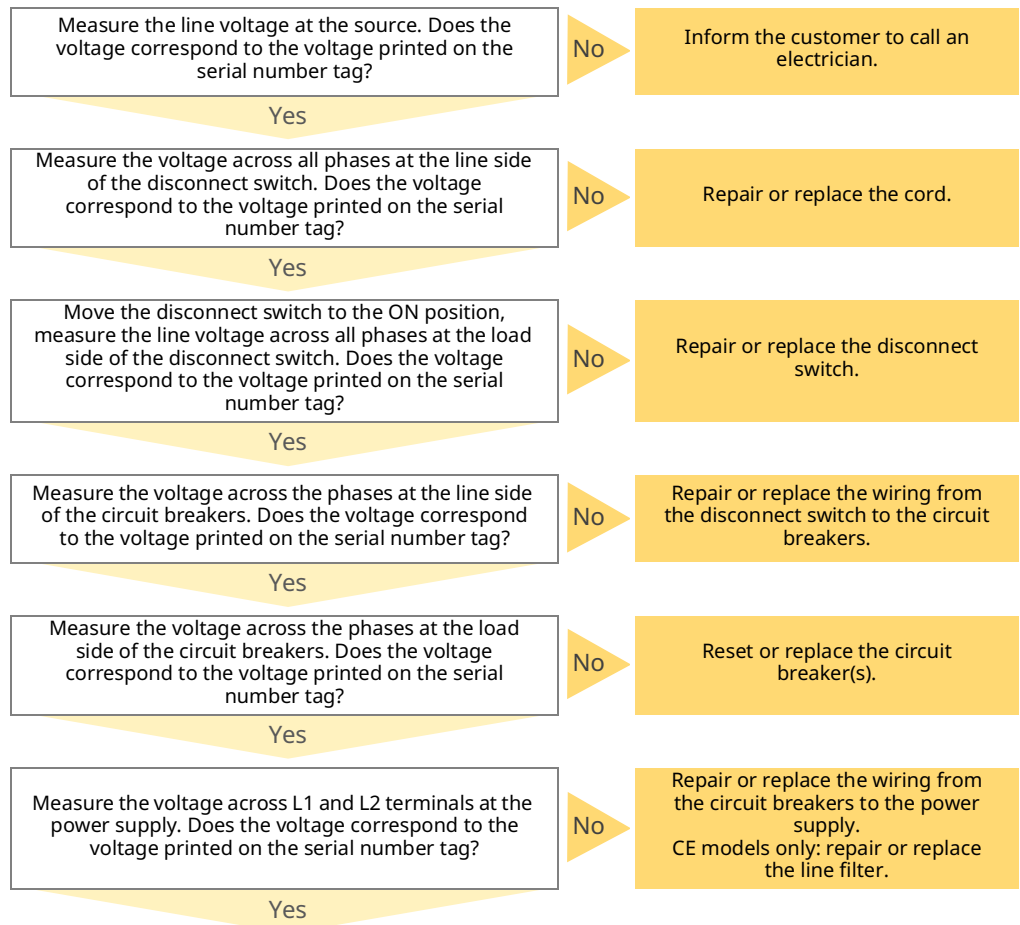

Continued on next page

Continued from previous page

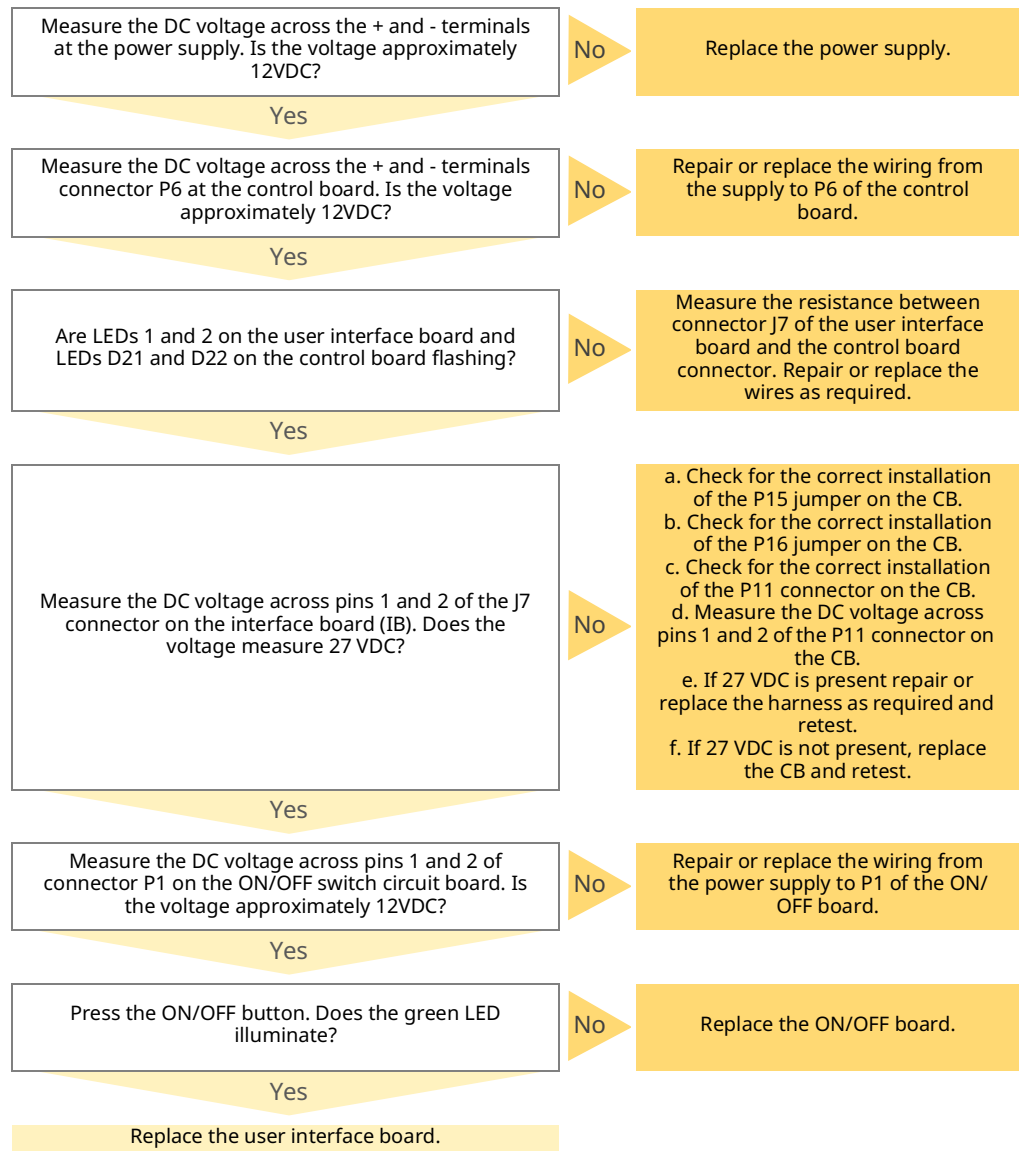

The Screen will not Turn On

Before you begin

- Move the main disconnect switch on the back of the oven to the OFF position.
- Move the main disconnect switch on the back of the oven to the ON position.
- The stripe screen should flash on the control panel and go blank.
- Press the ON/OFF button.
- If the striped screen displays, but the oven will not turn on when the ON/OFF button is pressed, follow the troubleshooting procedure below.
- If the stripe screen does not flash follow the "Oven will not power up troubleshooting".



WARNING: Electric shock and arc flash hazard.
Use caution when measuring line voltage.
Wear Personal Protective Equipment (PPE).

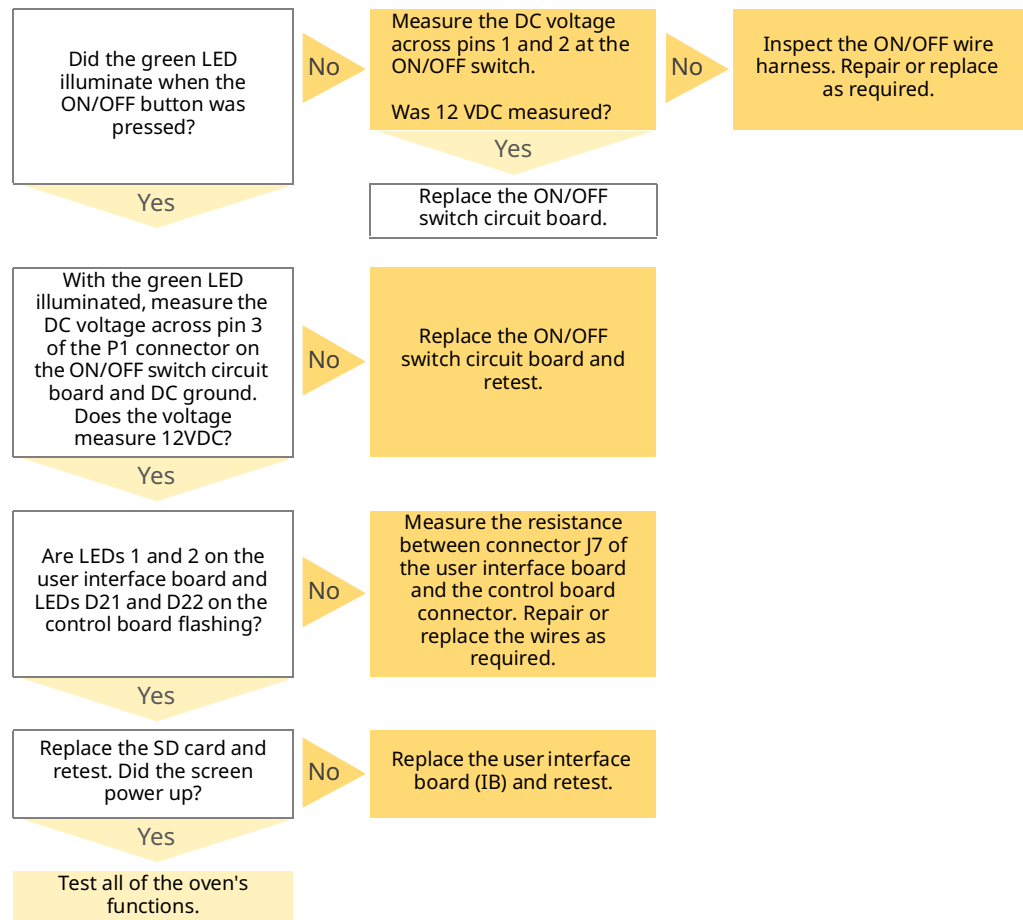

The Screen will not power down or the oven will not enter cool down mode

Before you begin

- Read and record the oven temperature for each chamber.
- Press and hold the ON/OFF button.
- If the oven chamber temperatures are below 140°F / 60°C the oven control will power down.
- If the oven chamber temperatures are above 140°F / 60°C the oven will go into cool down mode.
- In cool down mode, the chamber blower fans will shutdown at 159°F / 70°C or lower. The cooling fans will shutdown at 139°F / 59°C or lower.



WARNING: Electric shock and arc flash hazard.

Use caution when measuring line voltage.

Wear Personal Protective Equipment (PPE).

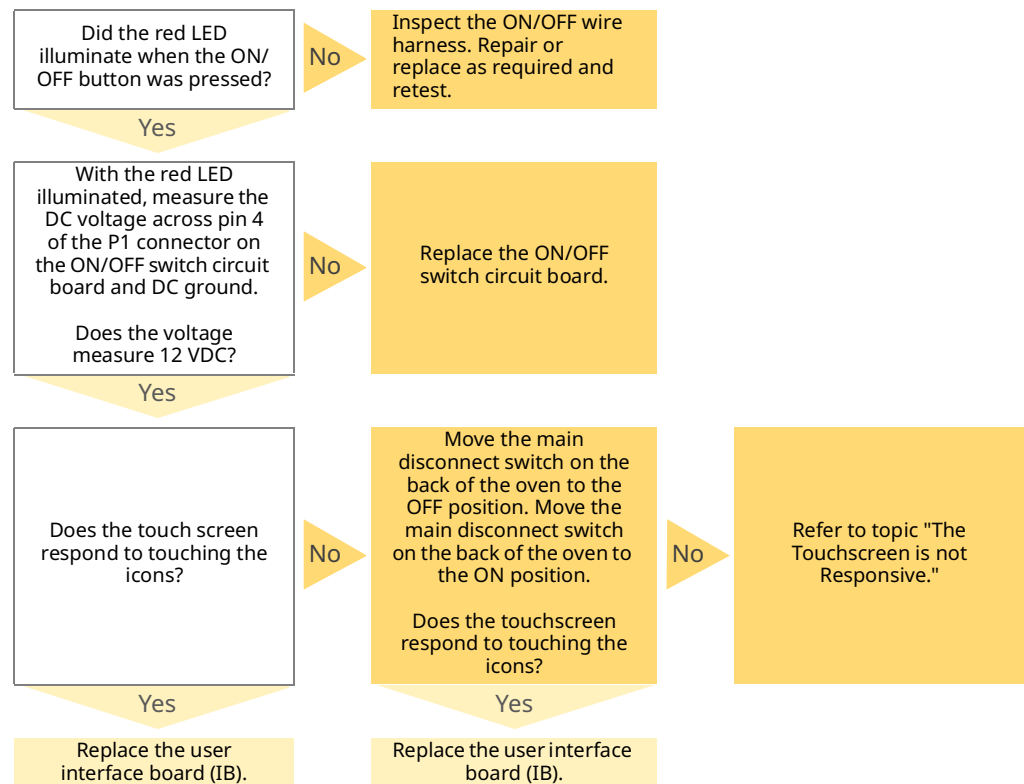

The Screen is Solid White

Before you begin

- Move the main disconnect switch on the back of the oven to the OFF position.
- Move the main disconnect switch on the back of the oven to the ON position.
- The stripe screen should flash on the control panel and go blank.
- If the screen is solid white contact Alto-Shaam Technical Service for the "Force Load file".
- The file will be emailed to you and you will we need the ability to load the file to a USB drive with the following requirements.
- USB drive requirements:
 - Blank with NO other files or folders on it.
 - 8 GB or less.
 - Formatted to FAT 32.

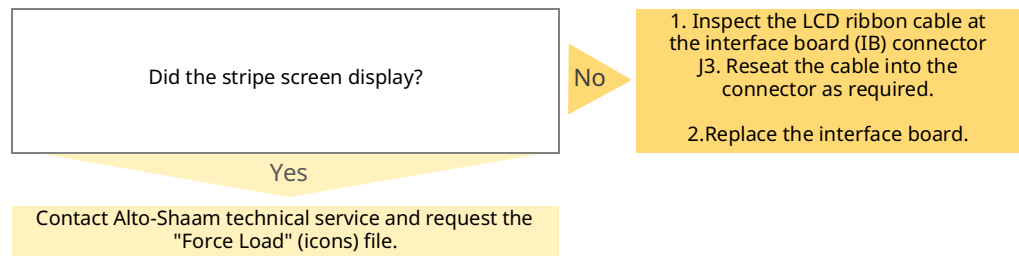

The Screen is not Responsive/Incorrect Response to the Selected Icon

Before you begin

- Move the main disconnect switch on the back of the oven to the OFF position.
- Move the main disconnect switch on the back of the oven to the ON position.
- The stripe screen should flash on the control panel and go blank.
- Press the ON/OFF button.
- If the icons display on the screen, but do not respond when touching them, follow the troubleshooting procedure below.



WARNING: Electric shock and arc flash hazard.
Use caution when measuring line voltage.
Wear Personal Protective Equipment (PPE).

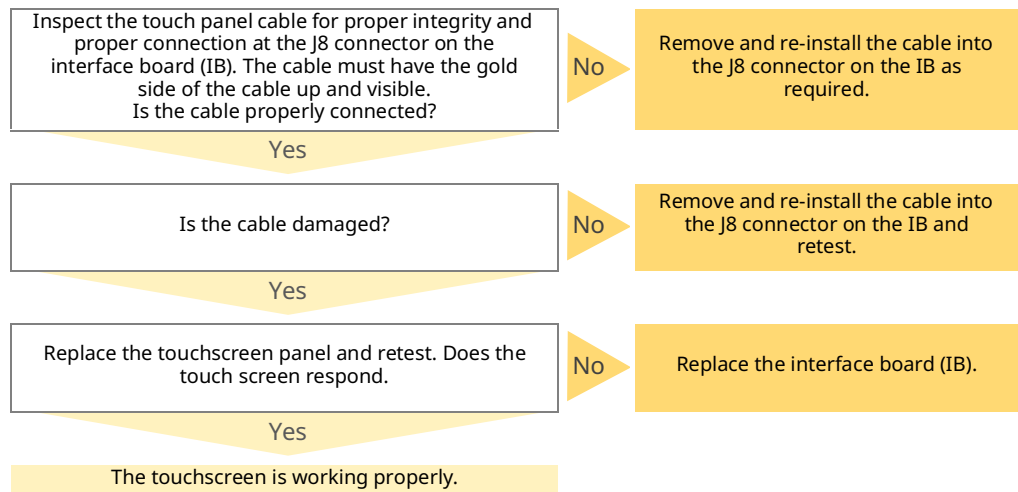

The Screen has Icons, but no Text

Before you begin

- Move the main disconnect switch on the back of the oven to the OFF position.
- Move the main disconnect switch on the back of the oven to the ON position.
- The stripe screen should flash on the control panel and go blank.
- Press the ON/OFF button. Allow the oven to power up.
- If the icons are still missing contact Alto-Shaam Technical Service for the "Force Load file".
- The file will be emailed to you and you will we need the ability to load the file to a USB drive with the following requirements.
- USB drive requirements:
 - Blank with NO other files or folders on it.
 - 8 GB or less.
 - Formatted to FAT 32.

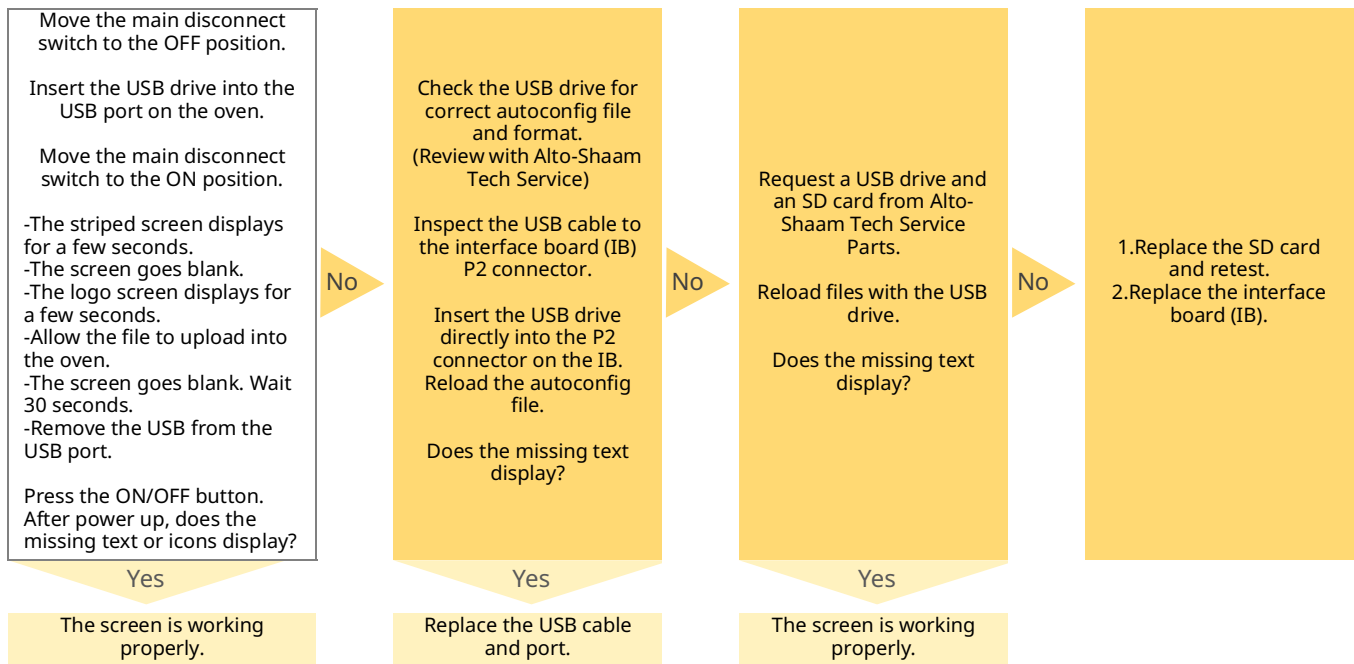

The Striped Screen is Locked—Continuous

Before you begin

- Inspect the USB port and the interface board (IB) remove USB drive if installed.
- Move the main disconnect switch on the back of the oven to the OFF position.
- Move the main disconnect switch on the back of the oven to the ON position.
- The stripe screen should flash on the control panel and go blank.
- Press the ON/OFF button. Allow the oven to power up.
- If the icons are still missing contact Alto-Shaam Technical Service for the "Force Load file".
- The file will be emailed to you and you will we need the ability to load the file to a USB drive with the following requirements.
- USB drive requirements:
 - Blank with NO other files or folders on it.
 - 8 GB or less.
 - Formatted to FAT 32.



WARNING: Electric shock and arc flash hazard.
Use caution when measuring line voltage.
Wear Personal Protective Equipment (PPE).

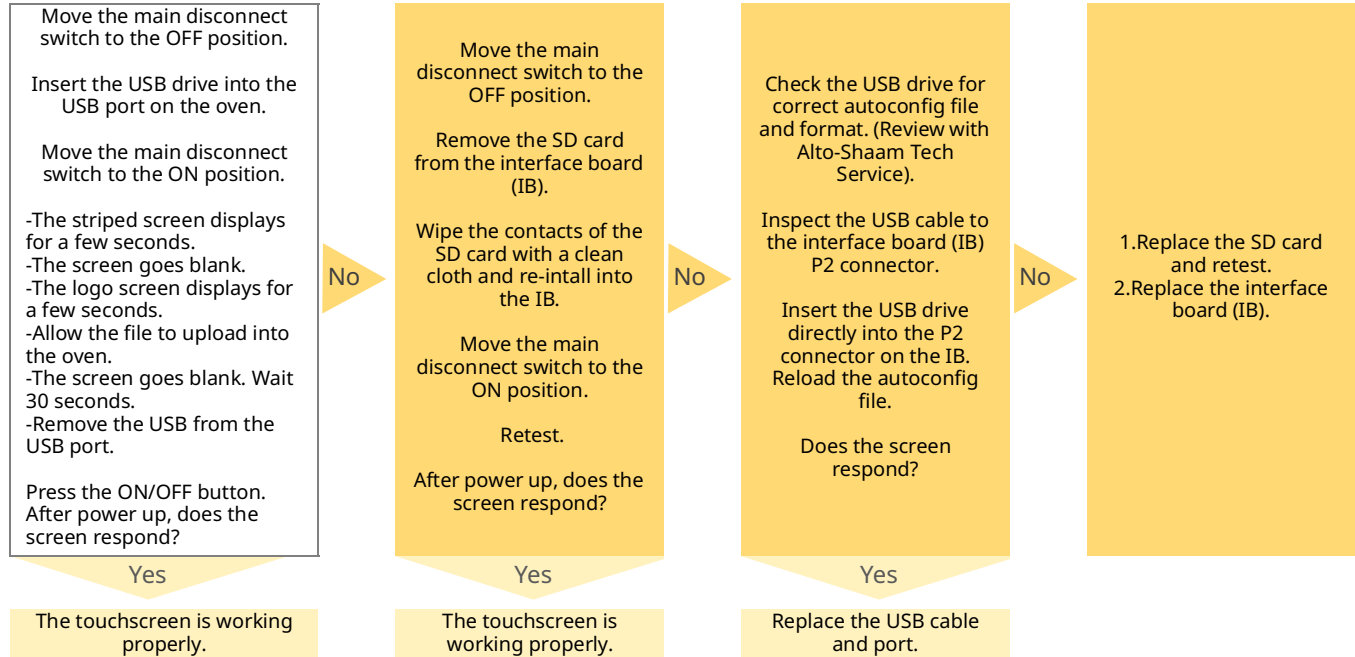

Chamber(s) do not Heat—Solid State Relay (SSR) Control Voltage not Present

Before you begin

Locate the temperature high limit switches and reset any tripped high limit switch as required. Locate the circuit breakers and reset any tripped circuit breaker as required. Put the oven into a heating mode. Remove the service panel.



WARNING: Electric shock and arc flash hazard.
Use caution when measuring line voltage.
Wear Personal Protective Equipment (PPE).



NOTE: The chamber blower fans must operate if the blower fans do not operate. See topic *Chamber Blower Fans do not Operate*.

NOTICE

Do not operate the oven in a cooking mode for an extended period of time with the top panel removed. Damage to the electronics may occur without adequate cooling airflow.
An auxiliary fan must be used if the oven will be operated in a cooking mode for an extended period of time with the top panel removed.

Continued on next page

Continued from previous page

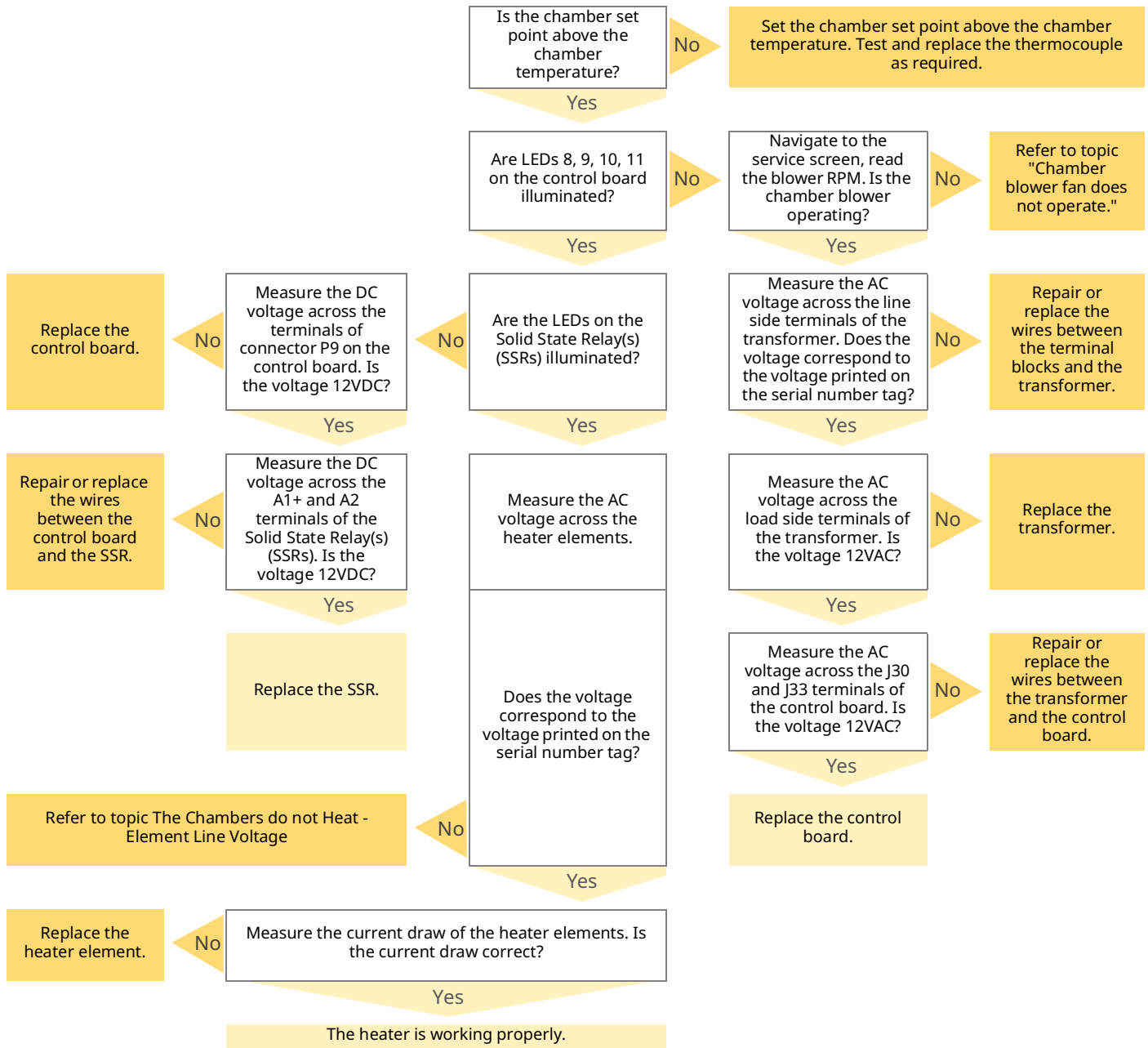

The Chamber(s) do not Heat—Heater Element Line Voltage (SSR is Energized)

How the heating element line voltage works

The heating elements require two phases of line voltage to operate. One phase originates at the main disconnect switch and is connected through a terminal board and then directly to the heating element. The second phase originates at the main disconnect switch and is connected through a terminal board, circuit breaker, chamber high limit switch and then to a solid state relay (SSR). The SSR controls the on time of the second phase of line voltage to the heating element.

Before you begin

- Read and follow the steps described in the topic The Chamber(s) do not Heat—Solid State Relay (SSR) Control Voltage.
- At the main disconnect switch, determine which phase connects directly to the heating element, and which phase connects to the L1 terminal of the SSR.
- Remove the service panel.



WARNING: Electric shock and arc flash hazard.
Use caution when measuring line voltage.
Wear Personal Protective Equipment (PPE).



NOTE: The chamber blower fans must operate if the blower fans do not operate. See topic *Chamber Blower Fans do not Operate*.

NOTICE

Do not operate the oven in a cooking mode for an extended period of time with the top panel removed. Damage to the electronics may occur without adequate cooling airflow.
An auxiliary fan must be used if the oven will be operated in a cooking mode for an extended period of time with the top panel removed.

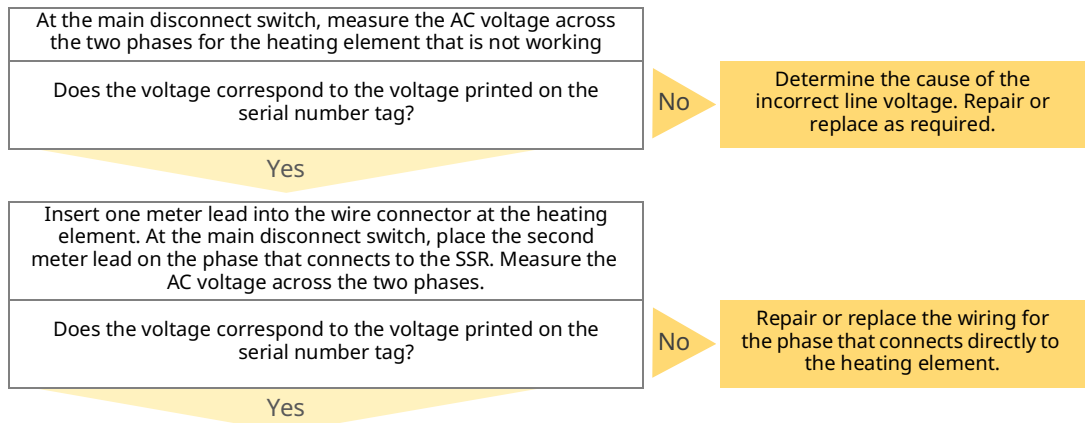

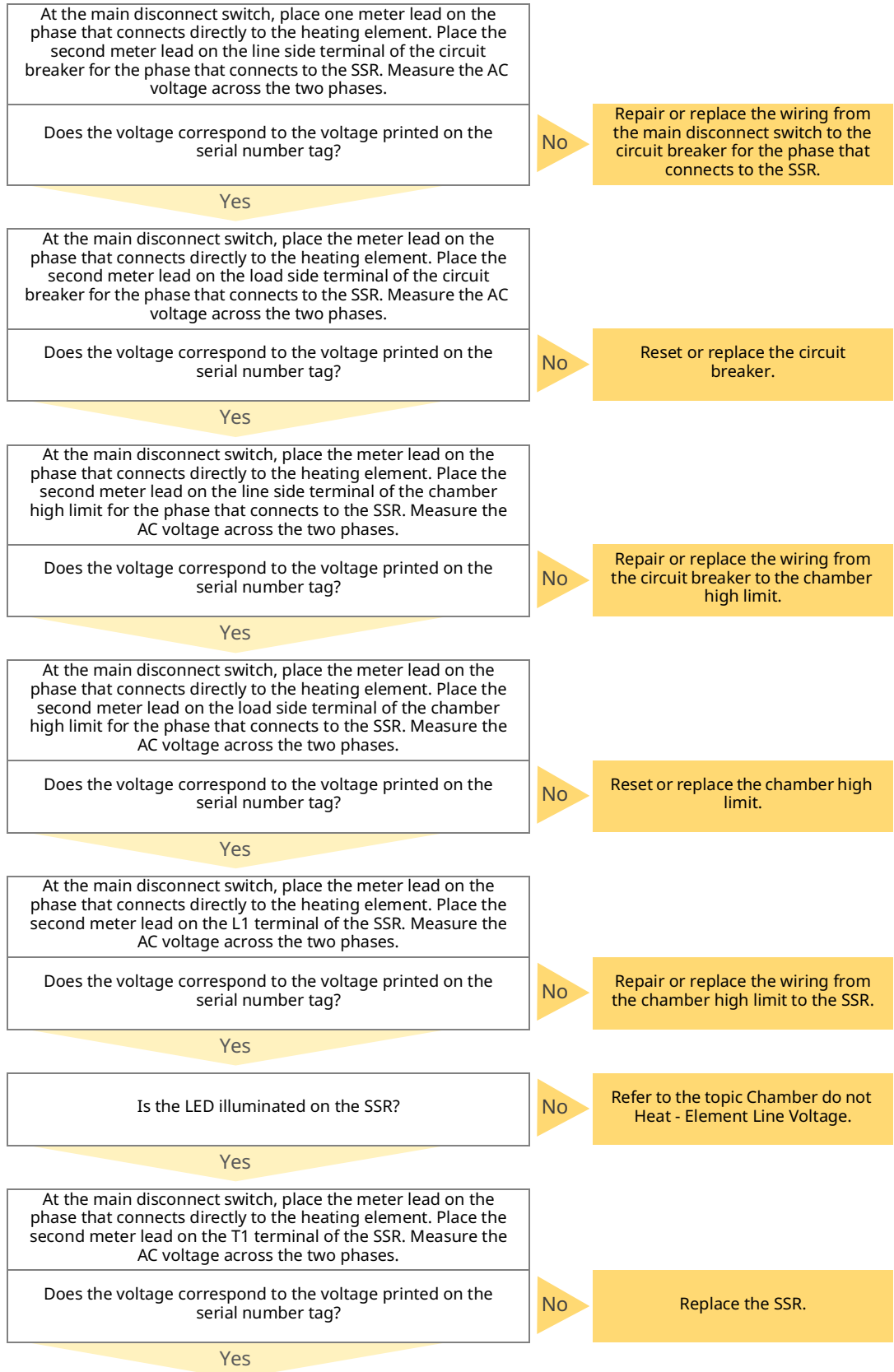

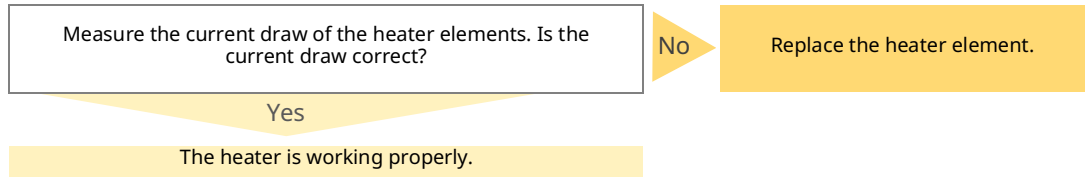

The Chamber is Slow to Heat

Before you begin

Remove the left service panel. Locate the power wires to the blower motor to be tested. Place an ammeter on one of the power wires to the blower motor.



WARNING: Electric shock and arc flash hazard.
Use caution when measuring line voltage.
Wear Personal Protective Equipment (PPE).



NOTE: The chamber blower fans must operate if the blower fans do not operate. See topic *Chamber Blower Fans do not Operate*.

NOTICE

Do not operate the oven in a cooking mode for an extended period of time with the top panel removed. Damage to the electronics may occur without adequate cooling airflow. An auxiliary fan must be used if the oven will be operated in a cooking mode for an extended period of time with the top panel removed.

Navigate to the service screen. Touch the blowers icon. Touch the motor speed for the motor to be tested. Change the motor speed to 100% and touch the check mark.

Is the amperage reading above 1 amp?

No

The blower motor maybe running backwards.

Locate the VFD for the blower motor being tested.

Locate the wire harness from the VFD to the terminal blocks. This harness has 1 small diameter white wire, 1 larger diameter white wire, 1 black wire and 1 green/yellow striped wire. Locate the small diameter white wire.

Inspect the connection of the small white wire into the terminal block. The small white wire needs to be in L1 terminal block only.

Reconnect as required.

Yes

The blower motor is working properly.

A Single Chamber Blower Fan does not Operate

Before you begin

- Locate the circuit breakers and reset any tripped circuit breaker as required.
- Remove the service panel.
- Navigate to the service screen, touch the blower test icon, set the blower speed to 100%, touch the check mark.



WARNING: Electric shock and arc flash hazard.
Use caution when measuring line voltage.
Wear Personal Protective Equipment (PPE).

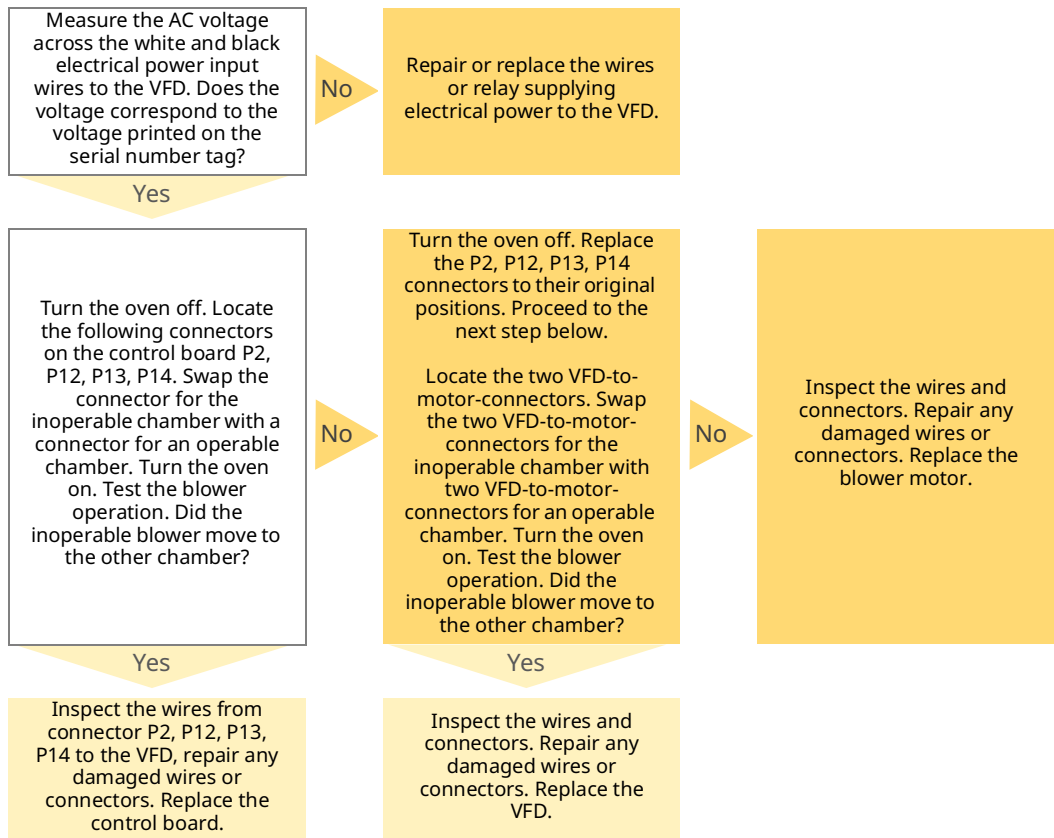

All Chamber Blower Fans do not Operate

Before you begin

- Locate the circuit breakers and reset any tripped circuit breaker as required.
- Remove the service panel.
- Navigate to the service screen, touch the blower test icon, set the blower speed to 100%, touch the check mark.



WARNING: Electric shock and arc flash hazard.

Use caution when measuring line voltage.

Wear Personal Protective Equipment (PPE).

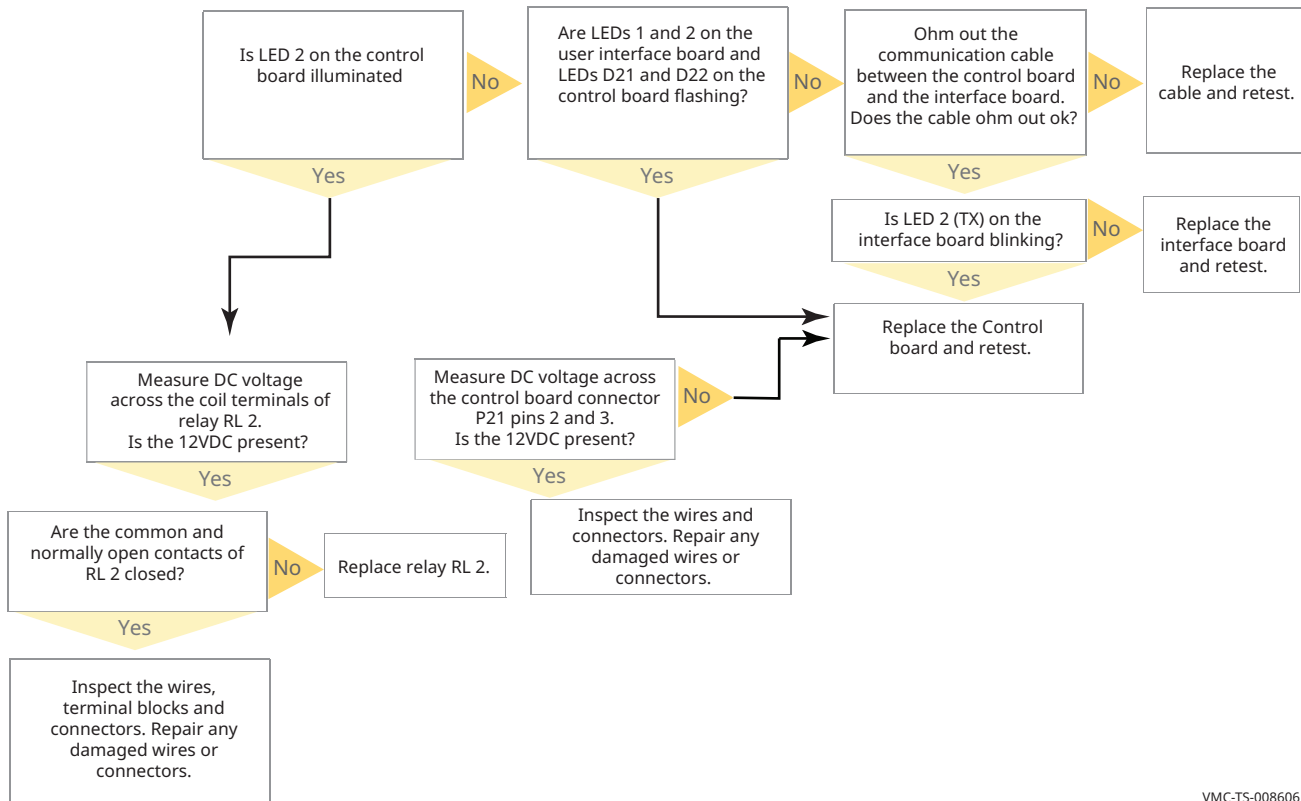

VMC-TS-008606

Chamber Light do not Illuminate

Before you begin

Navigate to the service screen, locate the "Door Lights" icon. Touch the icon to change between door lights mode "Green" and chamber lights mode "Red". Set the door lights to the proper mode for your oven.

If the lights turn off when the door is opened check the "Door Lights" mode. Activate the lights by touching the light icon on the display.

Remove the service panel.



WARNING: Electric shock and arc flash hazard.
Use caution when measuring line voltage.
Wear Personal Protective Equipment (PPE).

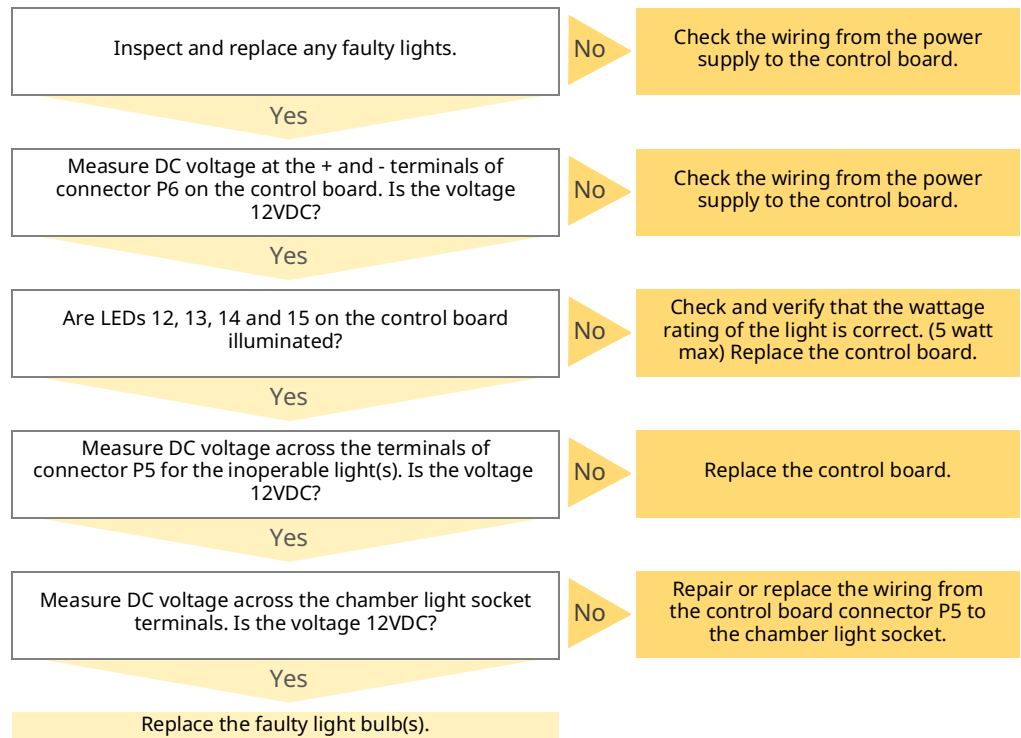

The Check Fan Indicator Light is Illuminated

Before you begin

- Inspect the cooling fan filters. Clean and replace as required.
- Put the oven into a cooking mode.
- Remove the service panel.



WARNING: Electric shock and arc flash hazard.
Use caution when measuring line voltage.
Wear Personal Protective Equipment (PPE).

NOTICE

Do not operate the oven in a cooking mode for an extended period of time with the top panel removed. Damage to the electronics may occur without adequate cooling airflow.
An auxiliary fan must be used if the oven will be operated in a cooking mode for an extended period of time with the top panel removed.

The indicator light is controlled by a 130°F (54°C) thermal switch. Are the cooling fans running?

No

Refer to topic "Cooling fans do not Operate."

Yes

Inspect the area around the oven for a high ambient heat source and air flow restrictions.

Correct the high heat source, and or air flow restrictions as required.

Test that the thermal switch contacts open at 110° F (43°C) or less.

The Cooling Fan(s) do not Operate

Before you begin

Put the oven into a heating mode.



WARNING: Electric shock and arc flash hazard.
Use caution when measuring line voltage.
Wear Personal Protective Equipment (PPE).

NOTICE

Do not operate the oven in a cooking mode for an extended period of time with the top panel removed. Damage to the electronics may occur without adequate cooling airflow.
An auxiliary fan must be used if the oven will be operated in a cooking mode for an extended period of time with the top panel removed.

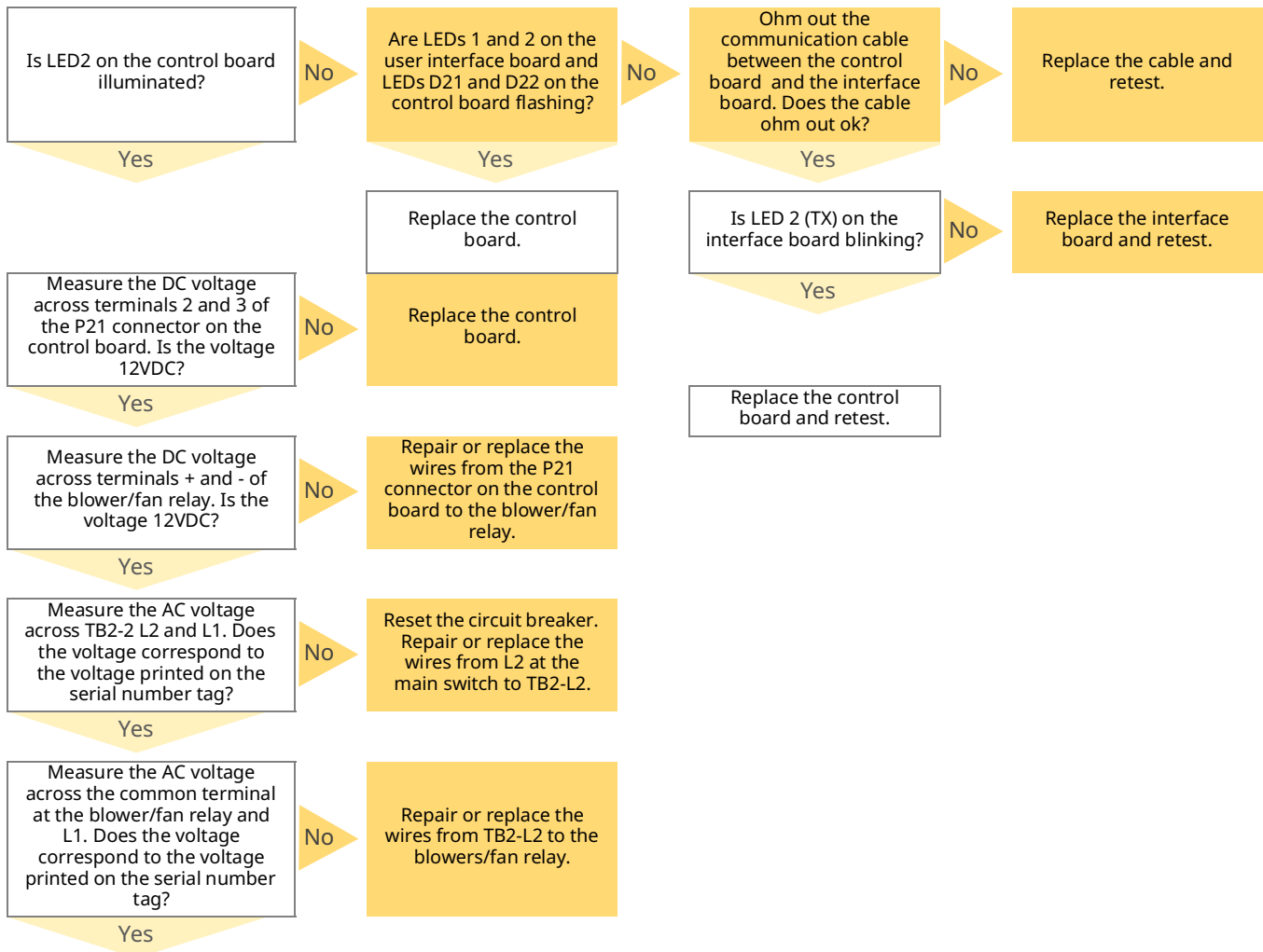

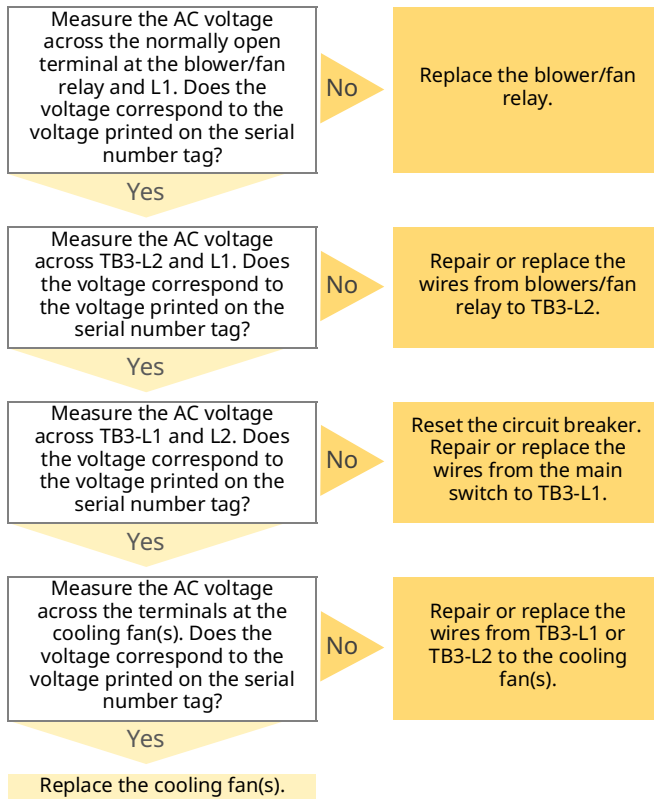

This page intentionally left blank.

Removing and Installing the Blower Motor

Before you begin

- The oven must be disconnected from electric power.
- Have a replacement blower motor.

Procedure

To remove and install the blower motor, do the following.



WARNING: Electric shock hazard.

Disconnect the appliance from electric power before servicing the appliance.

Step	Action
1.	Remove the top and right side service panels.

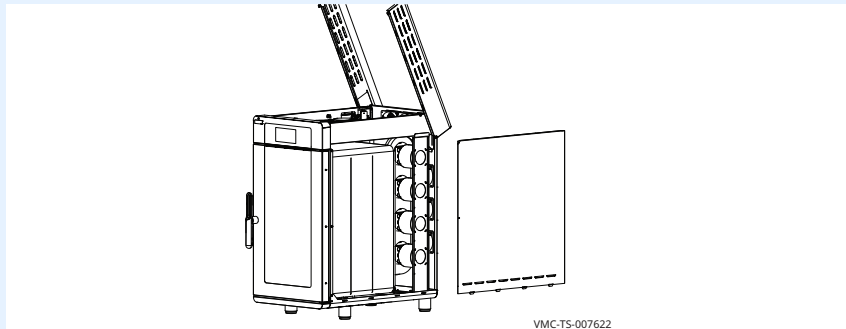

VMC-TS-007622

- | | |
|----|--|
| 2. | Disconnect the motor wire connectors. |
|----|--|



VMC-TS-002939

Continued on next page

Continued from previous page

3. **Remove** the mounting screws and remove the motor support plate.

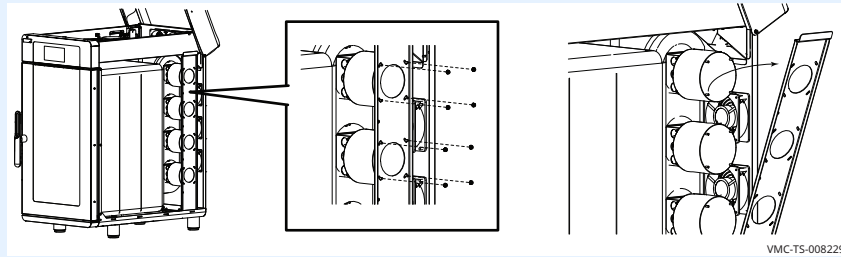

VMC-TS-008229

4. **Cut** the insulation around the motor.

Remove the three mounting screws and remove the motor and blower wheel from the housing.

Install the new motor with the three mounting screws. Tape all the seams in the insulation.

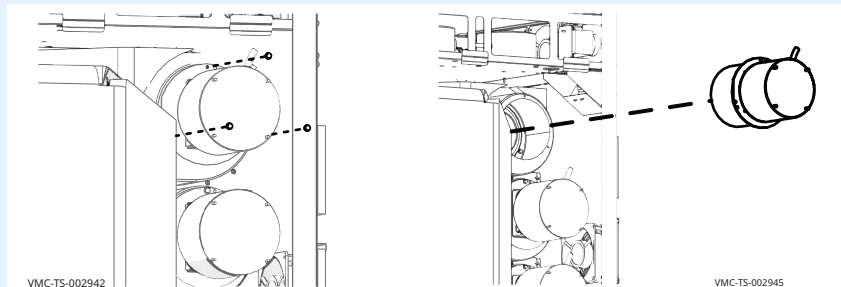

VMC-TS-002942

VMC-TS-002945

5. **Re-connect** the motor wire connectors.

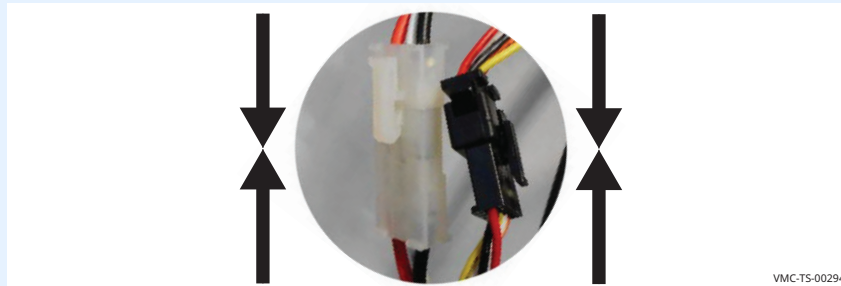

VMC-TS-002948

6. **Re-install** the motor support plate.

Re-install the top and right side service panels.

Connect electric power to the appliance and test all functions.

Result

The blower motor has been replaced.

Removing and Installing a Heater Element

Before you begin

- The oven must be disconnected from electric power.
- Have a replacement heater element.

Procedure

To remove and install a heater element, do the following.



WARNING: Electric shock hazard.

Disconnect the appliance from electric power before servicing the appliance.

Step	Action
1.	Open the top and remove the left side service panel.
	
2.	Disconnect the heater element wires.
	

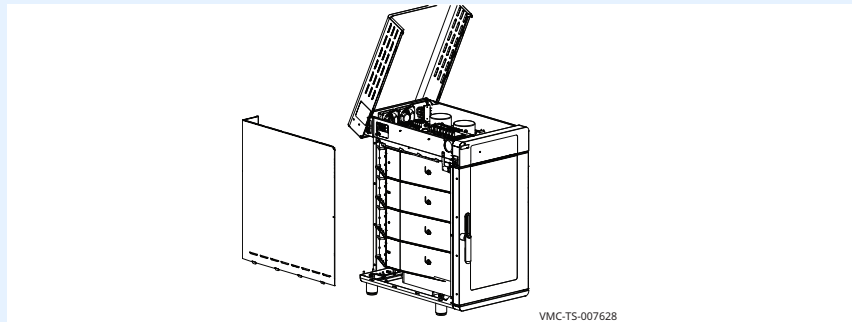

VMC-TS-007628

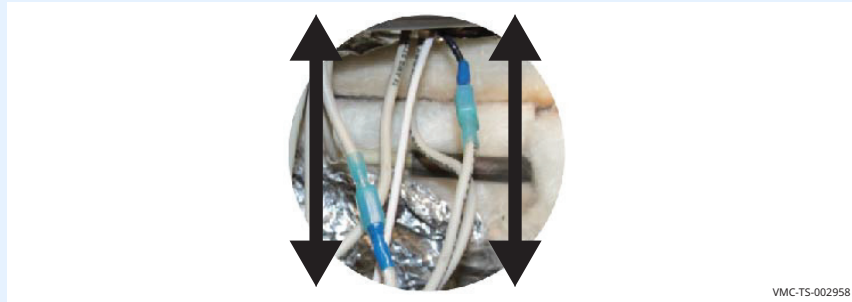

VMC-TS-002958

Continued on next page

Continued from previous page

3. **Cut** the insulation around the heater element panel.
Move the insulation away from the heater element panel.
Remove the heater element panel ①.

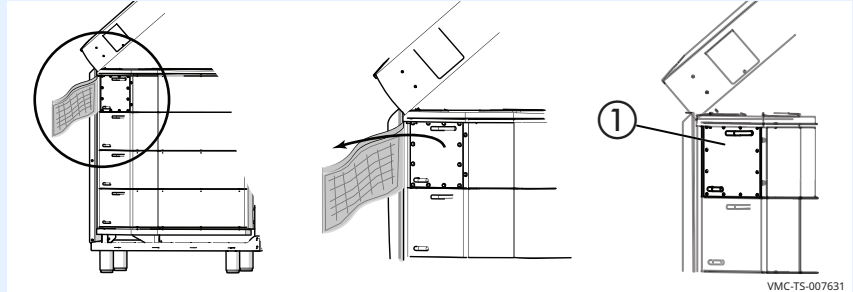

4. **Remove** the heater element ② from the oven.
Install the new heater element into the oven.

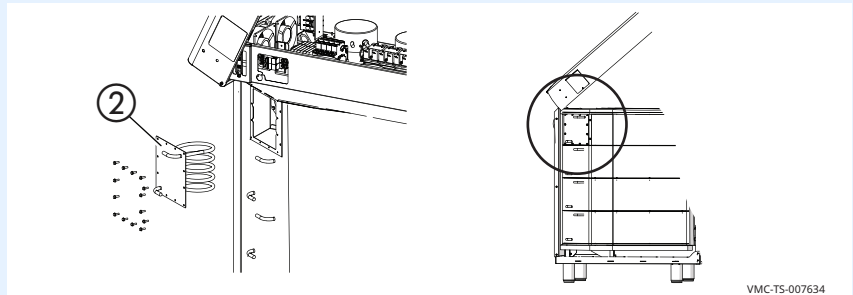

5. **Re-install** the heater element panel.
Re-install the insulation over the heater element panel. Tape all the seams of the insulation.

6. **Re-connect** the heater element wires.

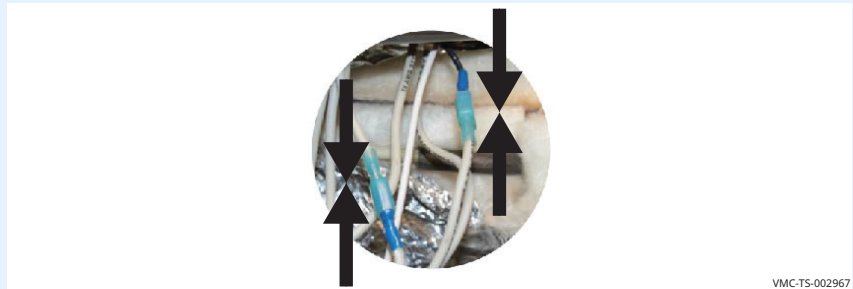

7. **Re-install** the top and left side service panels.
Connect electric power to the appliance and test all functions.

Result

The heater element has now been replaced.



208-240V 3Ph

77652

REV.	DATE	NAME	ECO	CHANGES	REVISION
3	10/23/2019	montev	181383	Remove Top & Bottom motor note, correct COM position.	3
2	7/17/2019	montev	181241	Remove 137 ohms resistor P11	PAGE 1/6
1	12/15/2018	montev	731145	Adding RGB P4 & ECR 180719	Alto-Shaam
0	12/15/2018	montev			
		NAME	ECO		
		77652			
		H4			
		208-240V 3Ph			

TABLE OF CONTENTS

MAIN & BRANCH CIRCUIT	PG 03
DRIVE, MOTOR, COOLING FAN	PG 04
SIMPLE CONTROL	PG 05
DELUXE CONTROL	PG 06

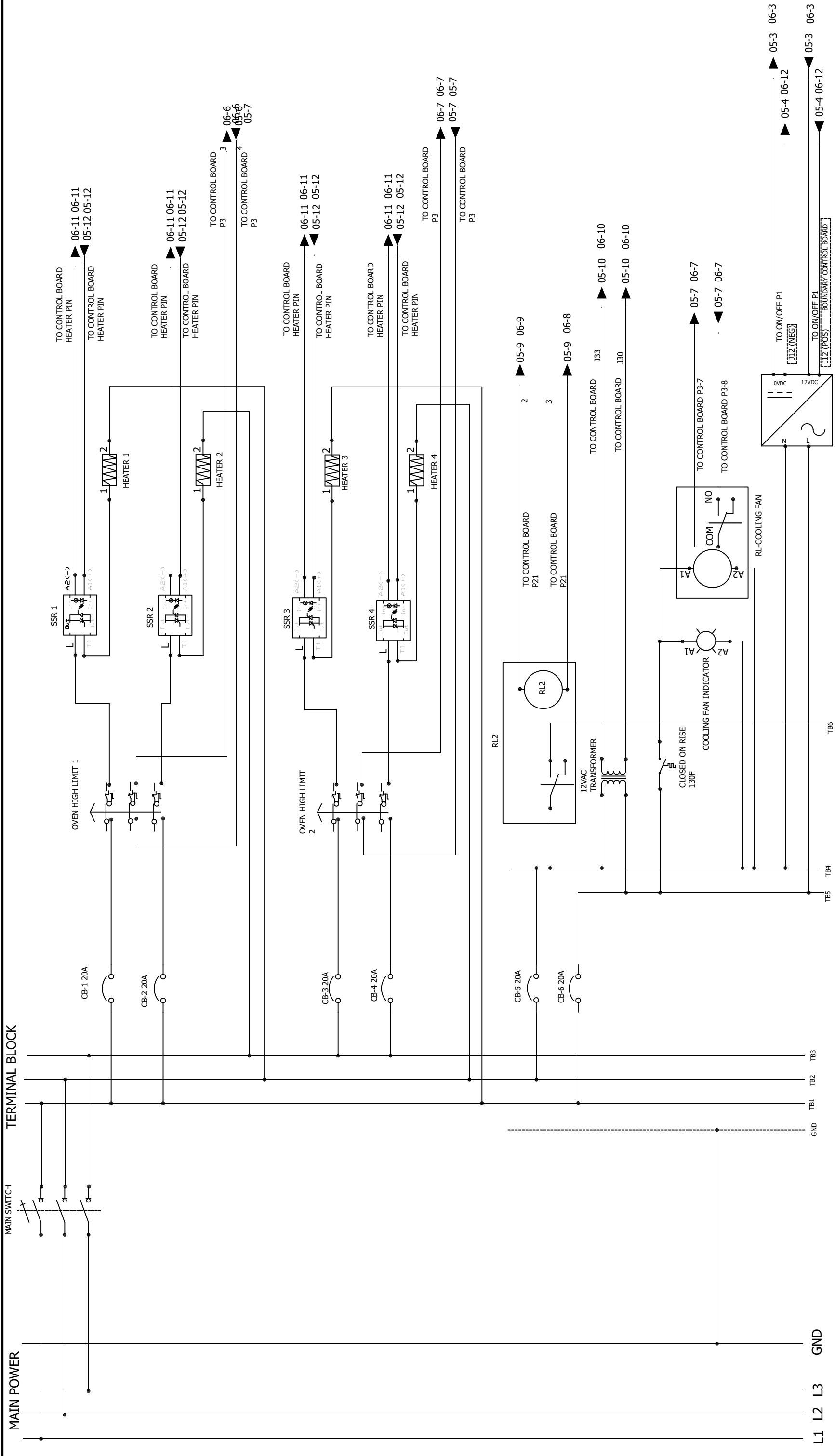

TERMINAL BLOCK

12

11

10

9

8

7

6

5

4

3

2

1

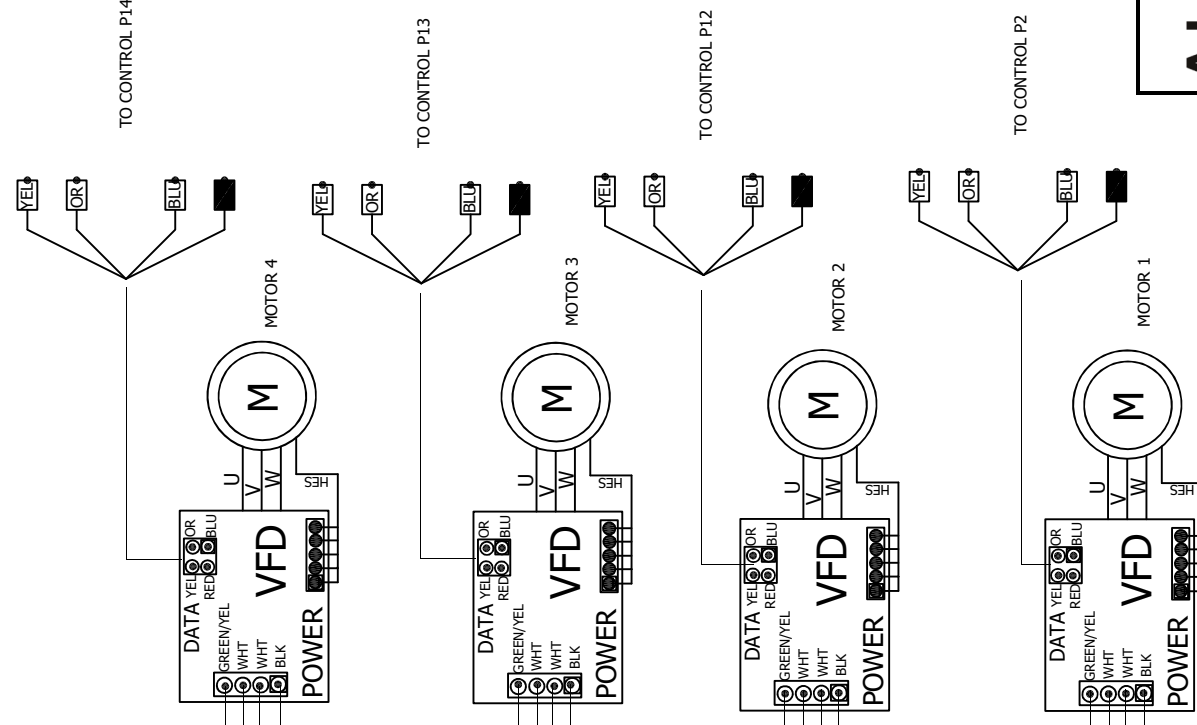
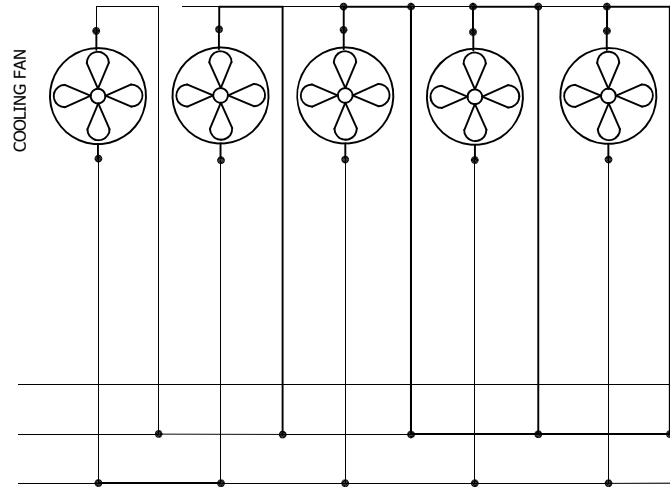

TB5-L1 TB6-L2 TB7-GND

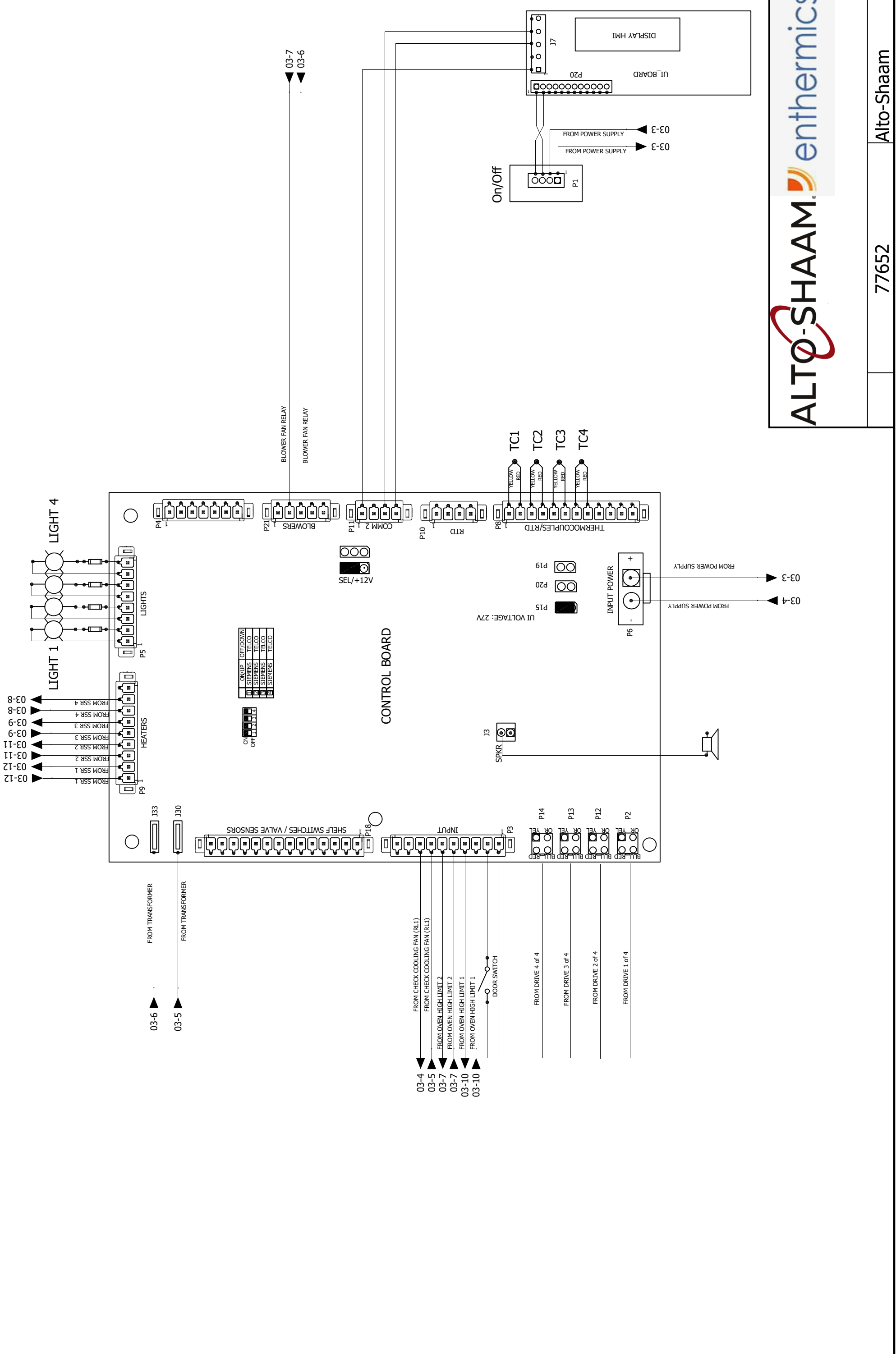

DELUXE CONTROL

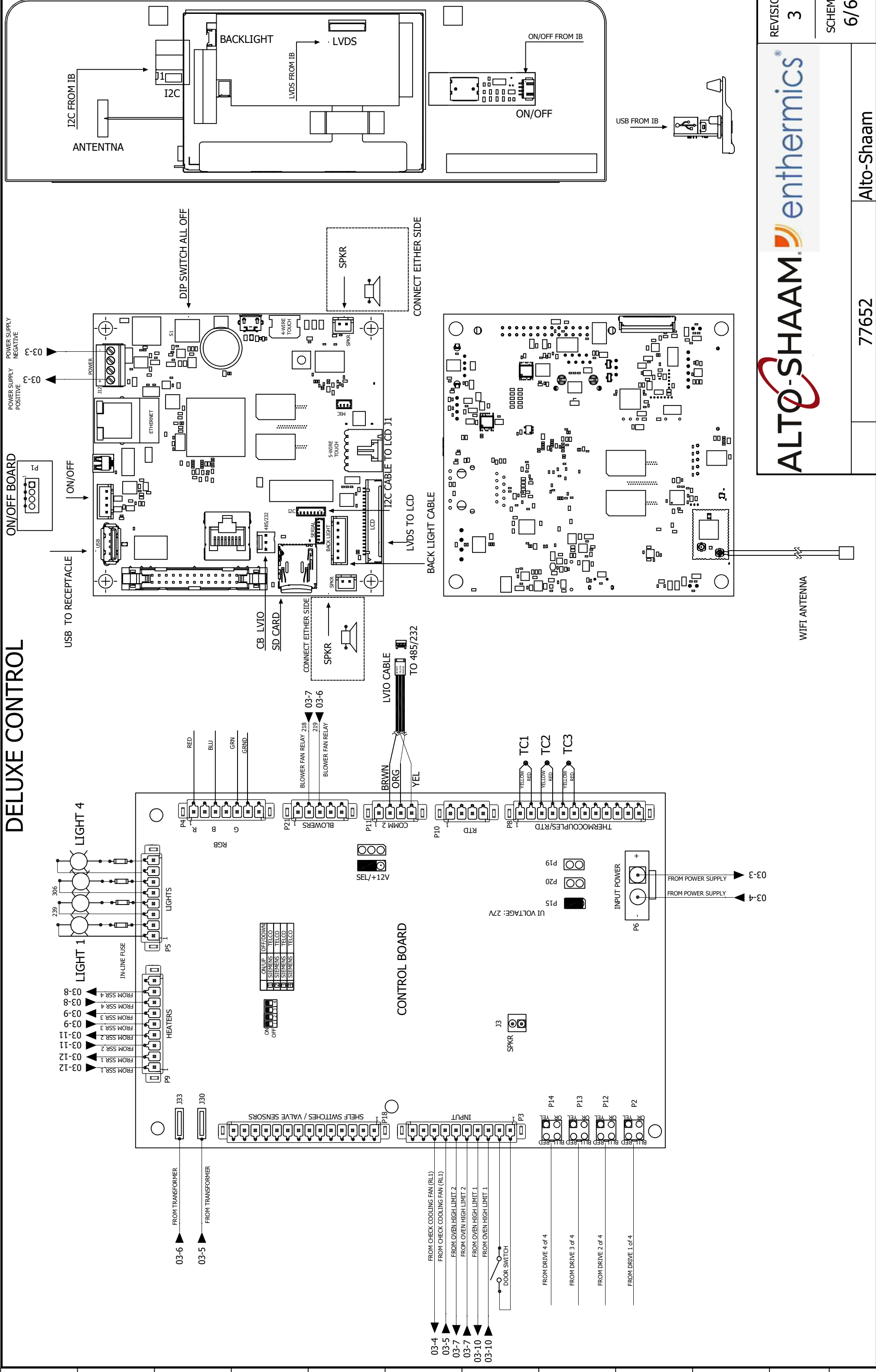



280-240V 1Ph

77653

REV.	DATE	NAME	ECO	CHANGES	REVISION
3	10/23/2019	montev	181383	Remove Top & Bottom motor note, correct COM position.	3
2	7/17/2019	montev	181241	Remove 137ohms resistor P11	PAGE 1/6
1	10/18/2018	montev	731145	Adding RGB P4 & ECR 180719	Alto-Shaam
0	5/17/2017	montev			
		NAME	ECO		
		77653 H3 280-240V 1Ph			

TABLE OF CONTENTS

MAIN & BRANCH CIRCUIT	PG 03
DRIVE, MOTOR, COOLING FAN	PG 04
SIMPLE CONTROL	PG 05
DELUXE CONTROL	PG 06

MAIN POWER

TERMINAL BLOCK

MAIN SWITCH

12

11

10

9

8

7

6

5

4

3

2

1

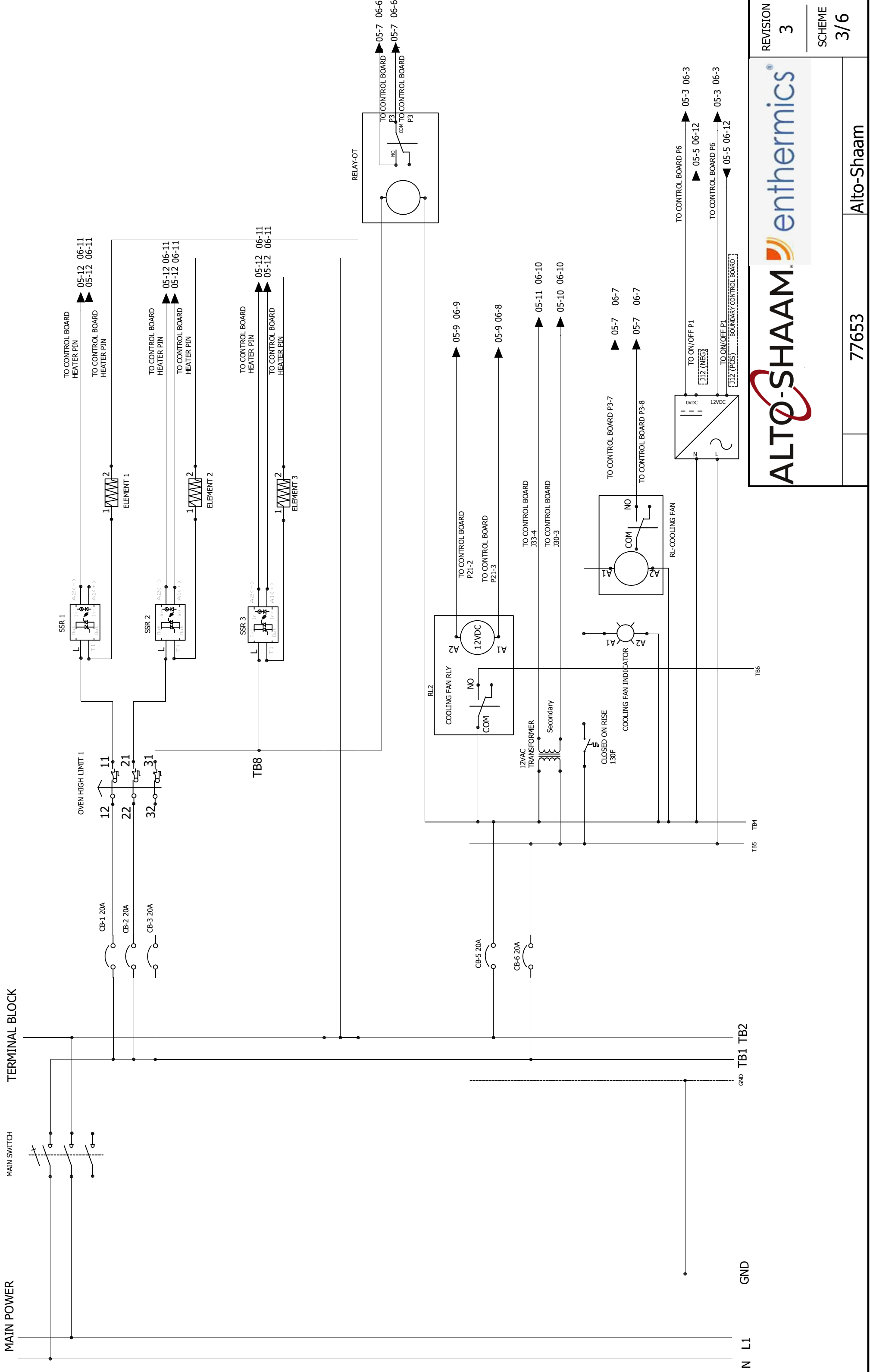

ALTO-SHAAM 

REVISION 3

SCHEME 3/6

77653

Alto-Shaam

12

11

10

9

8

7

6

5

4

3

2

1

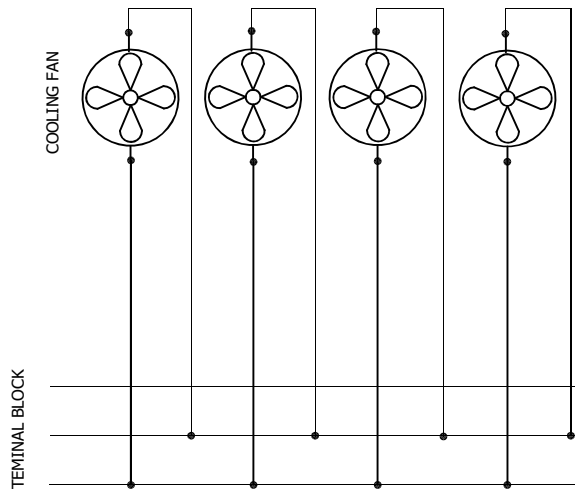

TERMINAL BLOCK

COOLING FAN

TO CONTROL P13

TO CONTROL P12

TO CONTROL P2

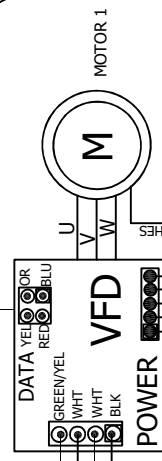
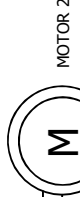
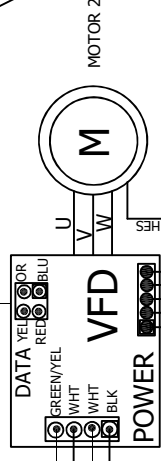
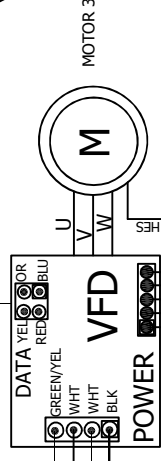

TB5-L1 TB7-GND

TB6-L2

12
11
10
9
8
7
6
5
4
3
2
1

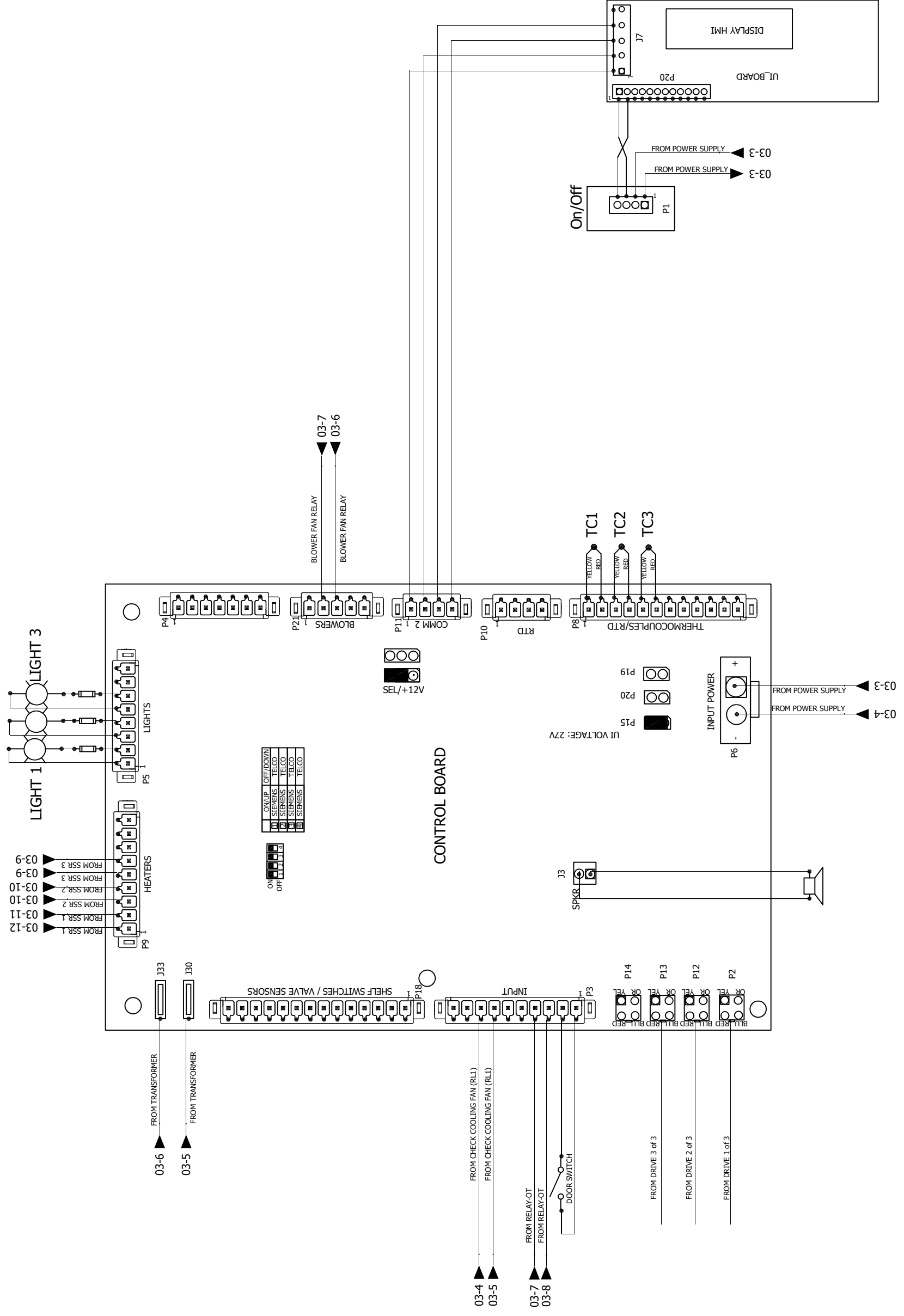

DELUXE CONTROL

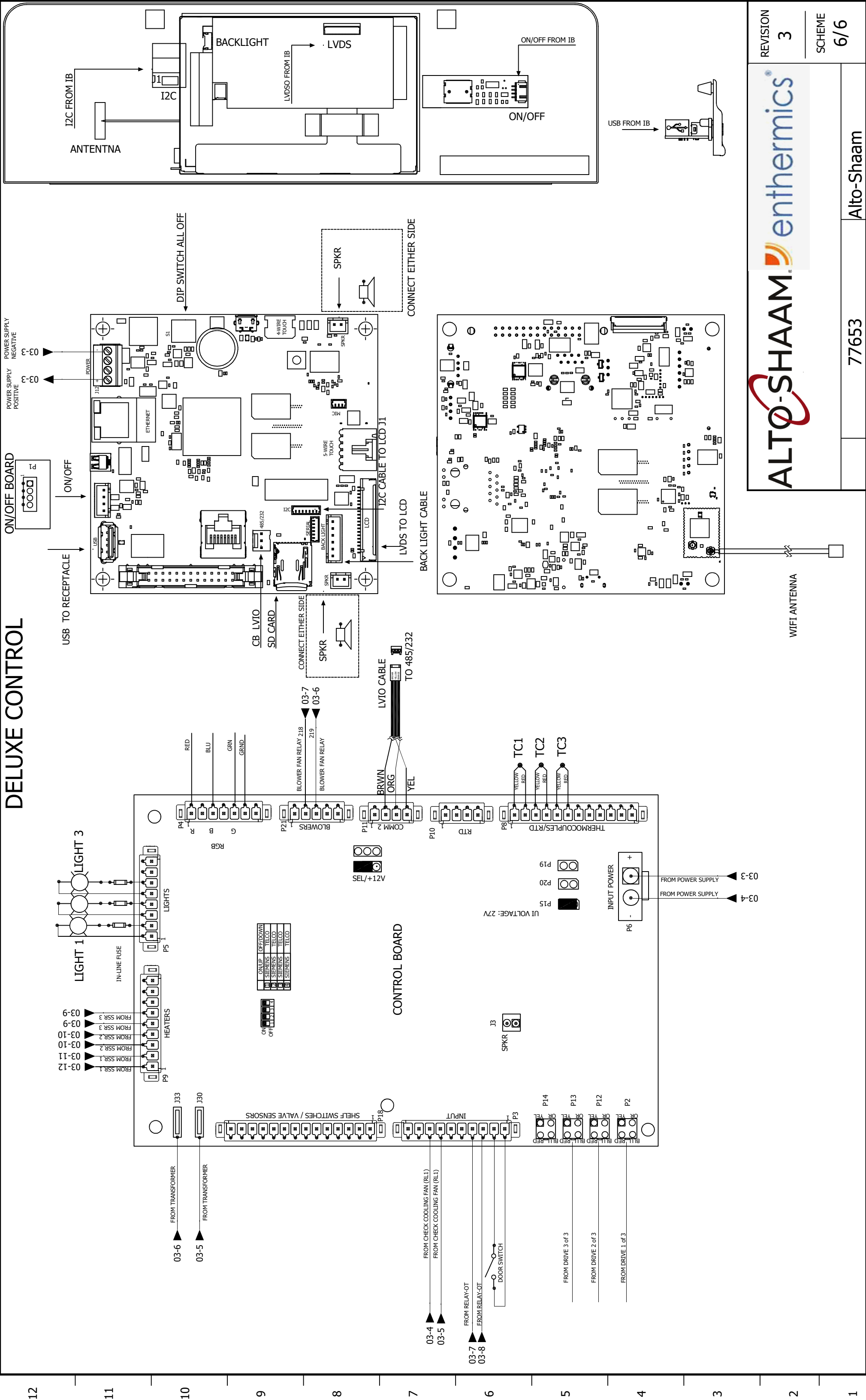



208-240V 1Ph 77654

REV.	DATE	NAME	ECO	CHANGES
3	10/23/2019	montev	181383	Remove Top & Bottom motor note, correct COM position.
2	7/22/2019	montev	181231	Update CAP touch
1	10/18/2018	montev	731145	Adding RGB P4
0	5/18/2017	montev		
77654 H2 208-240V 1Ph				
				REVISION
				3
				PAGE
				1/6

TABLE OF CONTENTS

MAIN & BRANCH CIRCUIT	PG 03
DRIVE, MOTOR, COOLING FAN	PG 04
SIMPLE CONTROL	PG 05
DELUXE CONTROL	PG 06

MAIN POWER

TERMINAL BLOCK

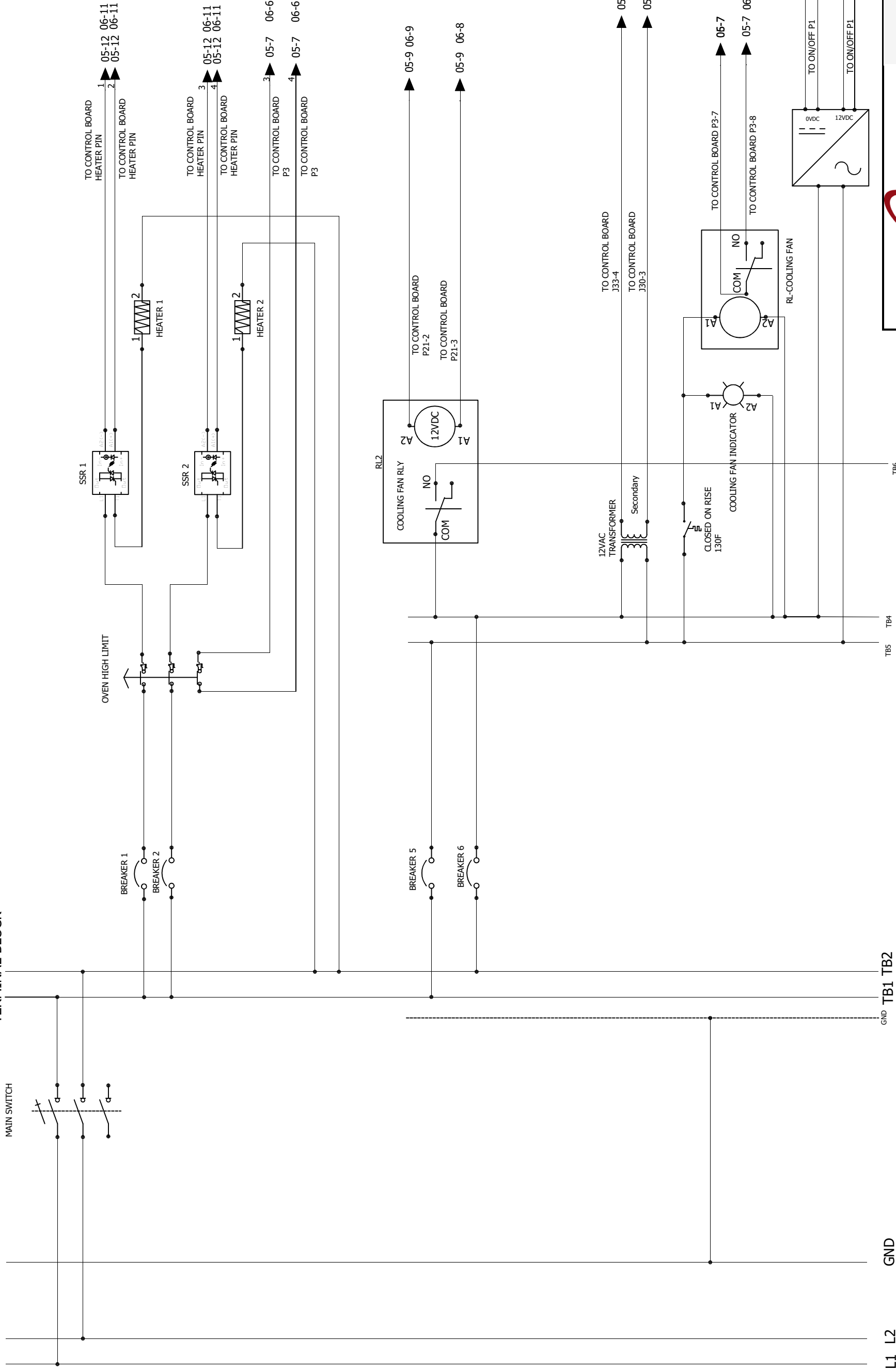

L1 L2 GND

GND TB1 TB2

TB5 TB4

TB6

TERMINAL BLOCK

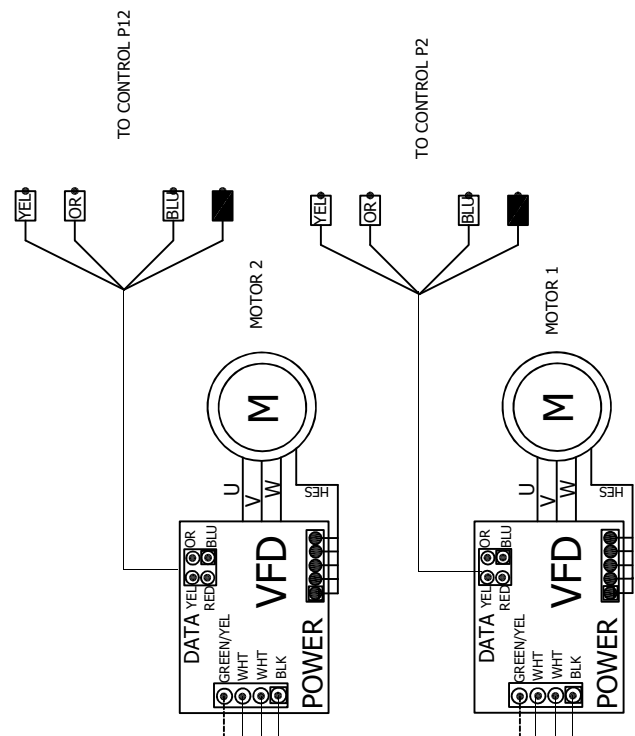
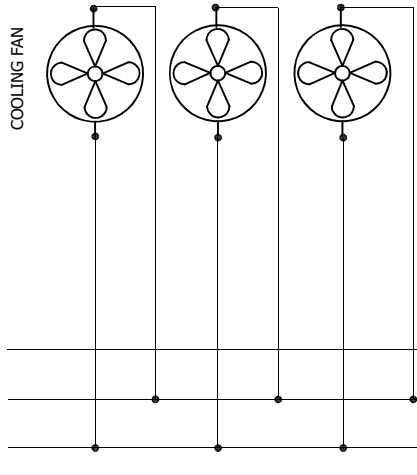

TB5-L1 TB6-L2 TB7-GND

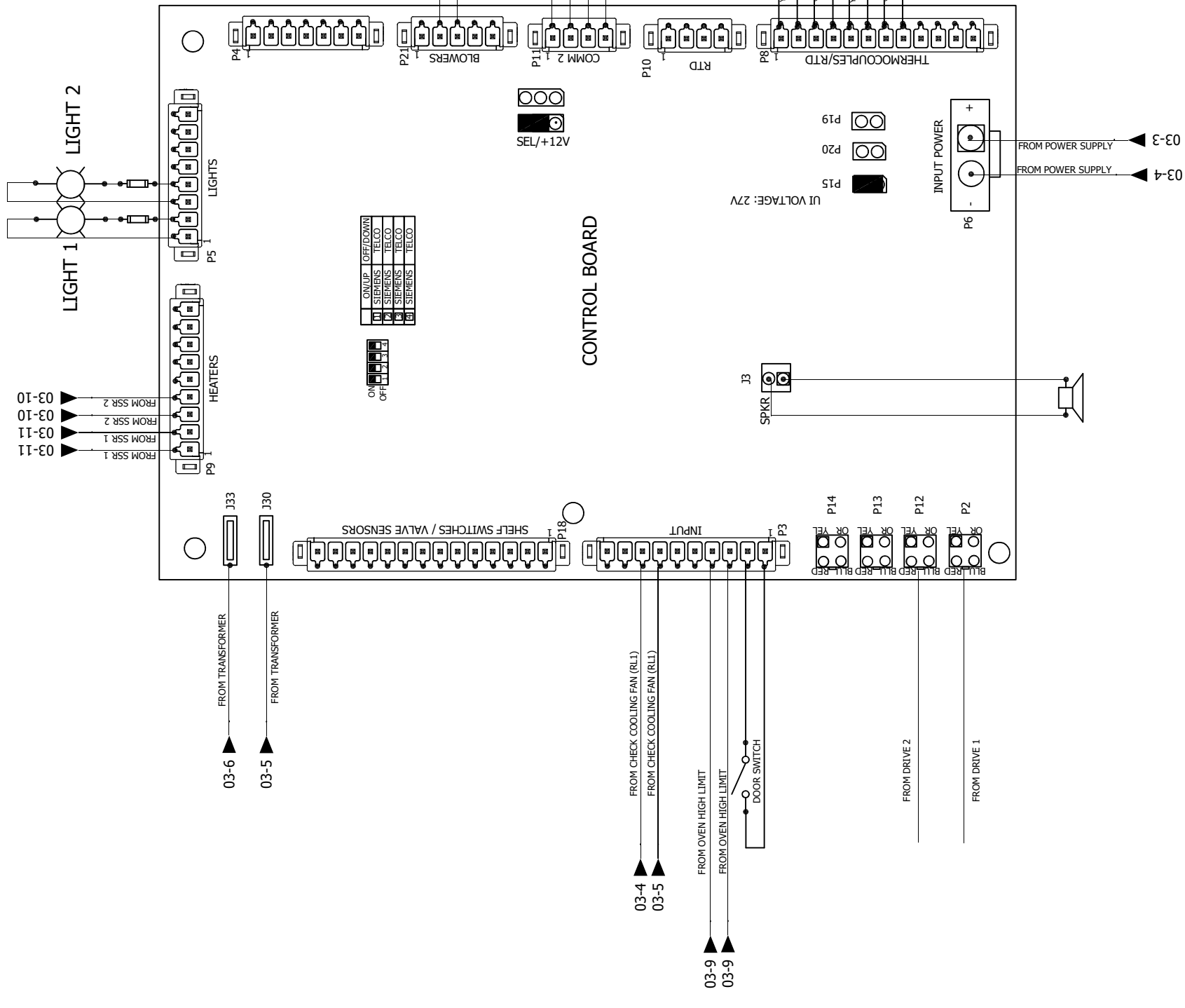

ON/UP	OFF/DOWN
1 SIEMENS	TELCO
2 SIEMENS	TELCO
3 SIEMENS	TELCO
4 SIEMENS	TELCO

380-415V 50Hz 3Ph

77661



REV.	DATE	NAME	ECO	CHANGES	REVISION
3	10/23/2019	montev	181383	Remove Top & Bottom motor note, correct COM position.	3
2	7/17/2019	montev	181241	Remove 137ohms resistor P.11	PAGE
1	10/18/2018	montev	731145	Adding RGB P4	1/6
0	8/22/2017	montev			
77661 H4 380-415V 50Hz 3Ph					Alto-Shaam

TABLE OF CONTENTS

MAIN & BRANCH CIRCUIT	PG 03
DRIVE, MOTOR, COOLING FAN	PG 04
SIMPLE CONTROL	PG 05
DELUXE CONTROL	PG 06

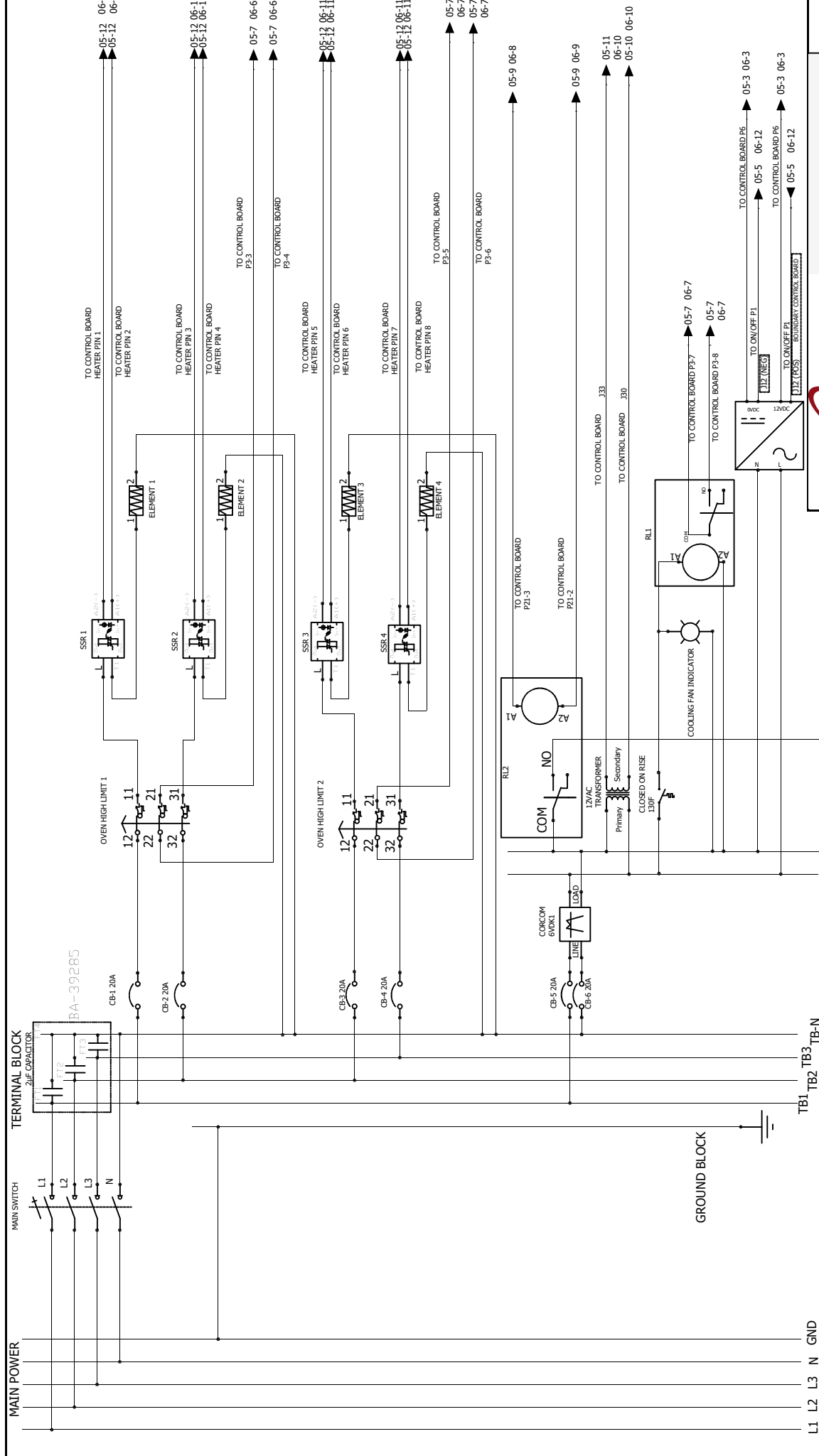

ALTO-SHAAM

REVISION **3**
 SCHEME **3/6**

77661 Alto-Shaam

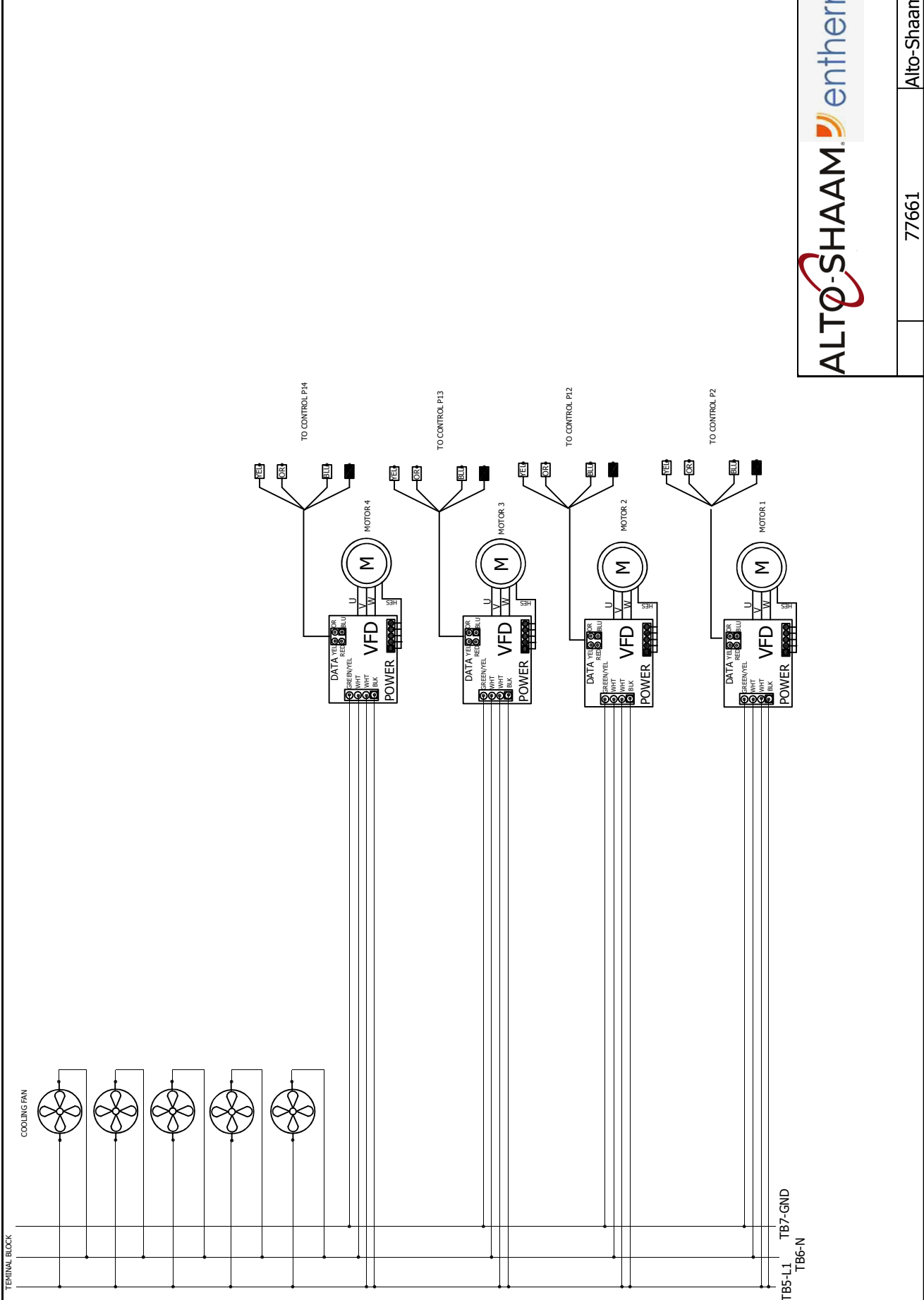

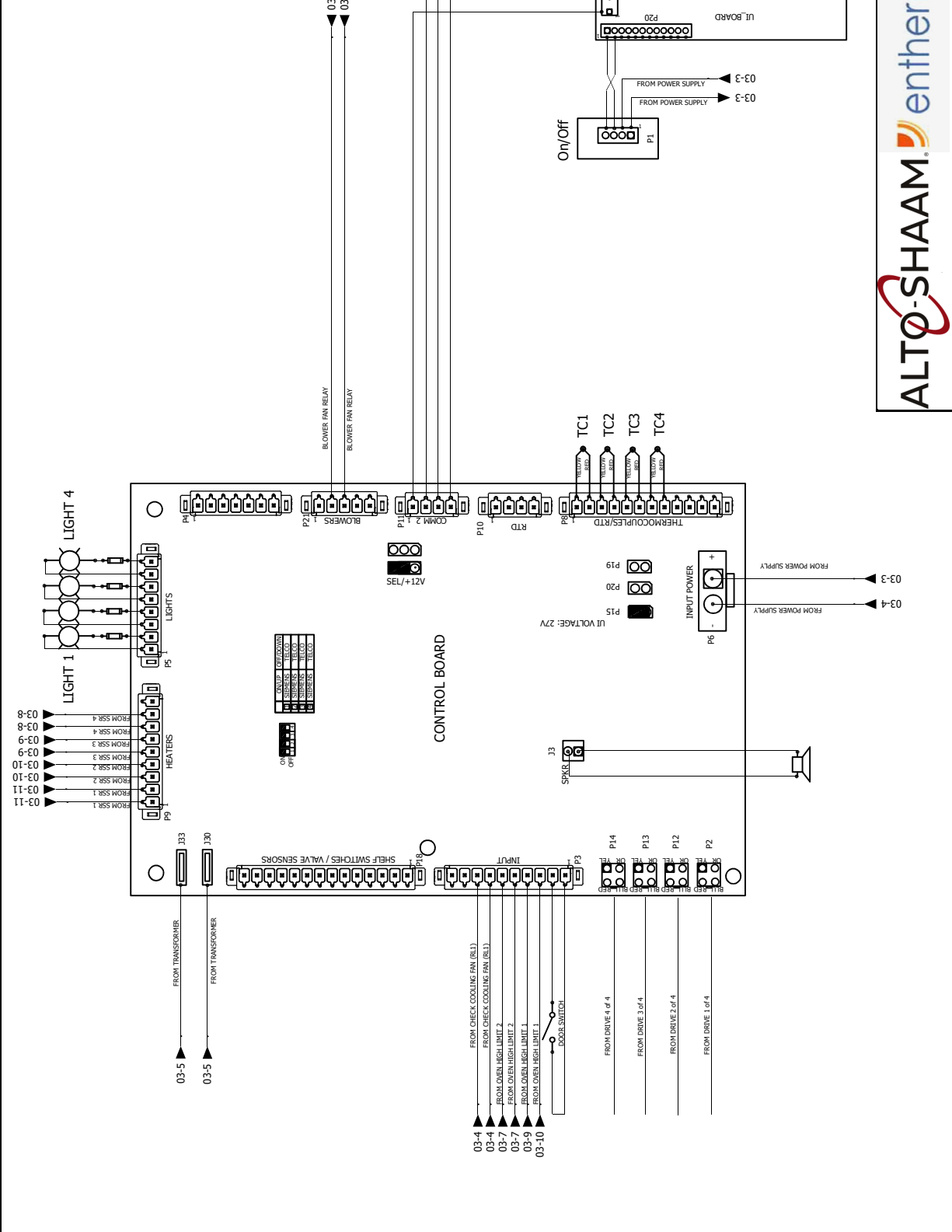

12
11
10
9
8
7
6
5
4
3
2
1

DELUXE CONTROL

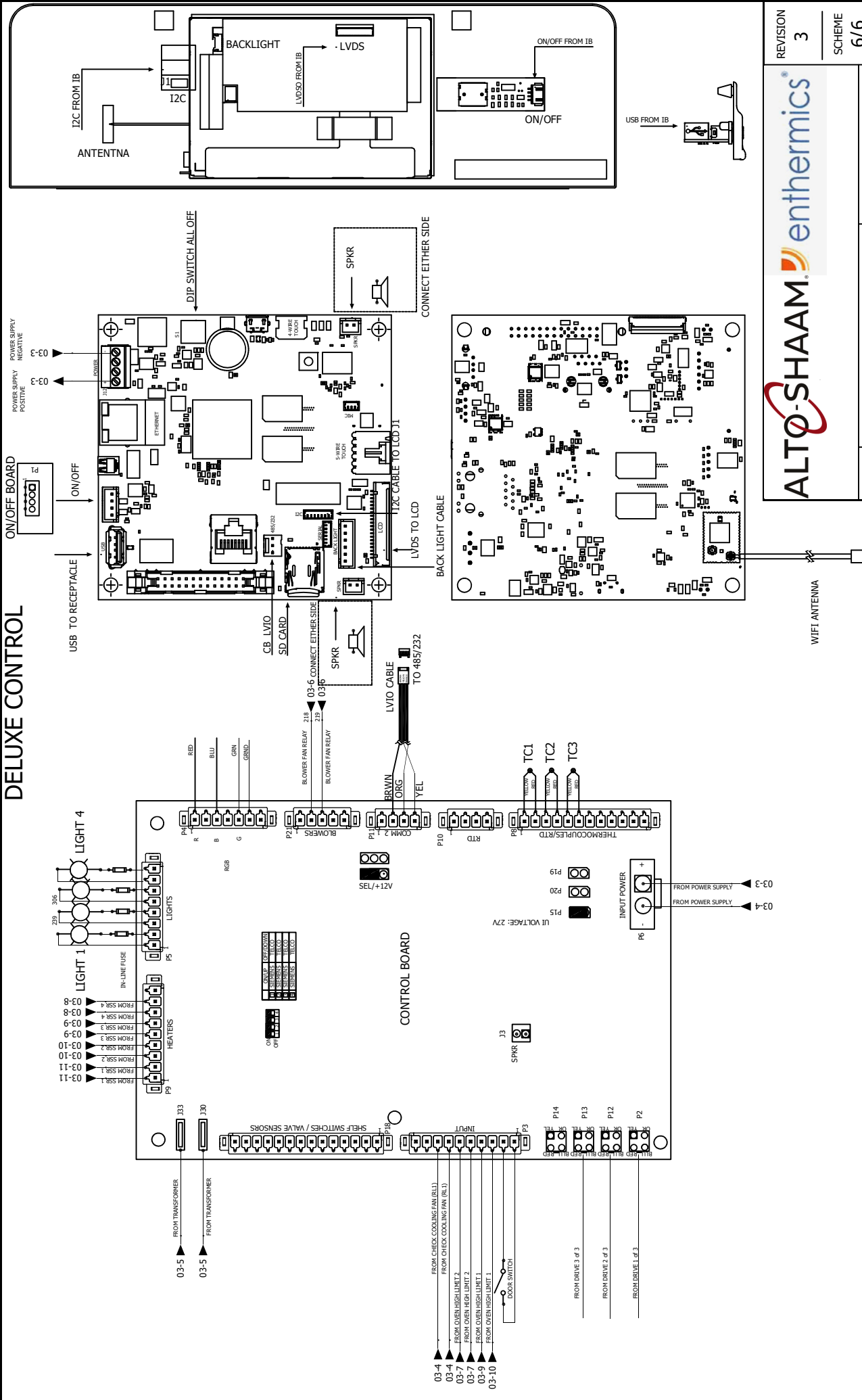



220v 50Hz 1pH

77664

REV.	DATE	NAME	ECO	CHANGES	REVISION
3	10/23/2019	montev	181383	Remove Top & Bottom motor note, correct COM position.	3
2	7/17/2019	montev	181241	Remove 137ohms resistor P11	PAGE
1	10/18/2018	montev	731145	Adding RGB P4	1/6
0	8/17/2017	montev			
77664 H2 220v 50Hz 1pH					Alto-Shaam

TABLE OF CONTENTS

MAIN & BRANCH CIRCUIT	PG 03
DRIVE, MOTOR, COOLING FAN	PG 04
SIMPLE CONTROL	PG 05
DELUXE CONTROL	PG 06

MAIN POWER

TERMINAL BLOCK

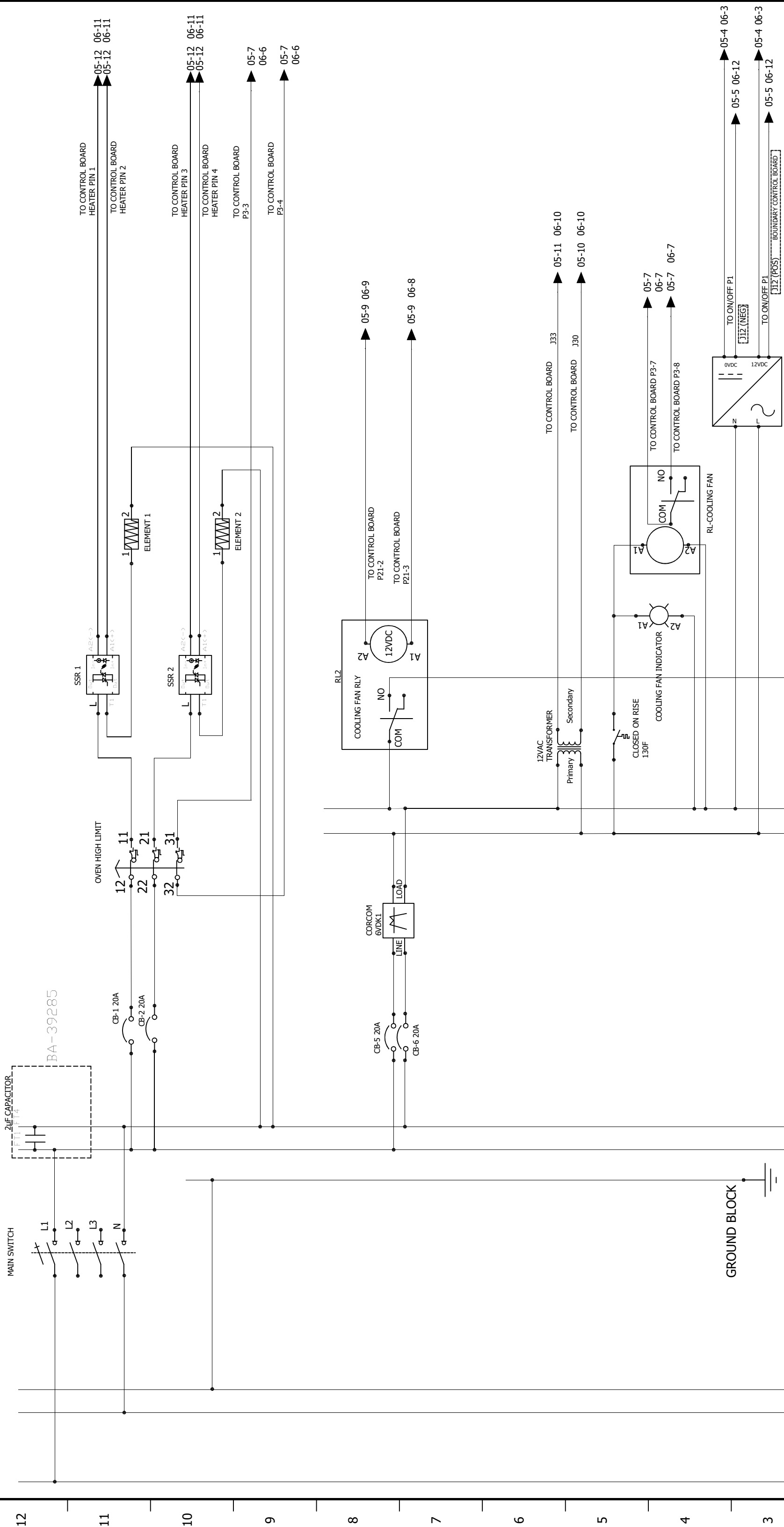

L1 N GND

TB1 TB2

TB5 TB4

TB6

77664



REVISION 3
SCHEME 3/6

Alto-Shaam

TERMINAL BLOCK

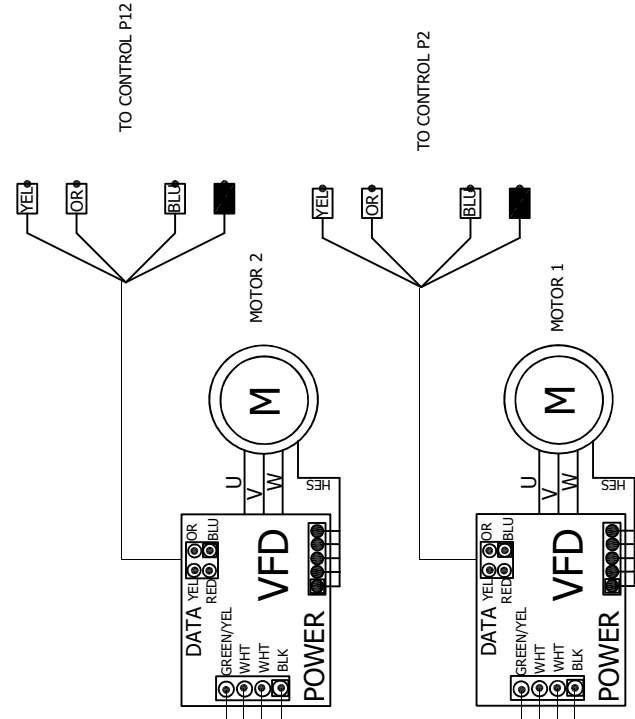
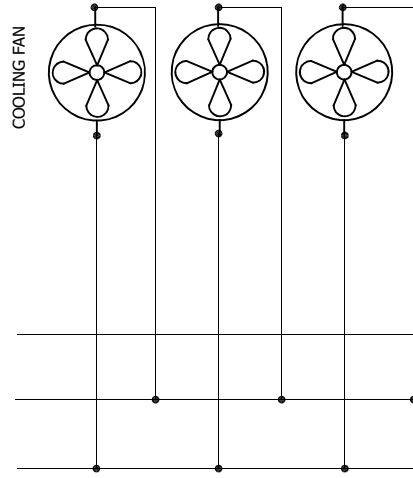

TB5-L1 TB7-GND
TB6-N

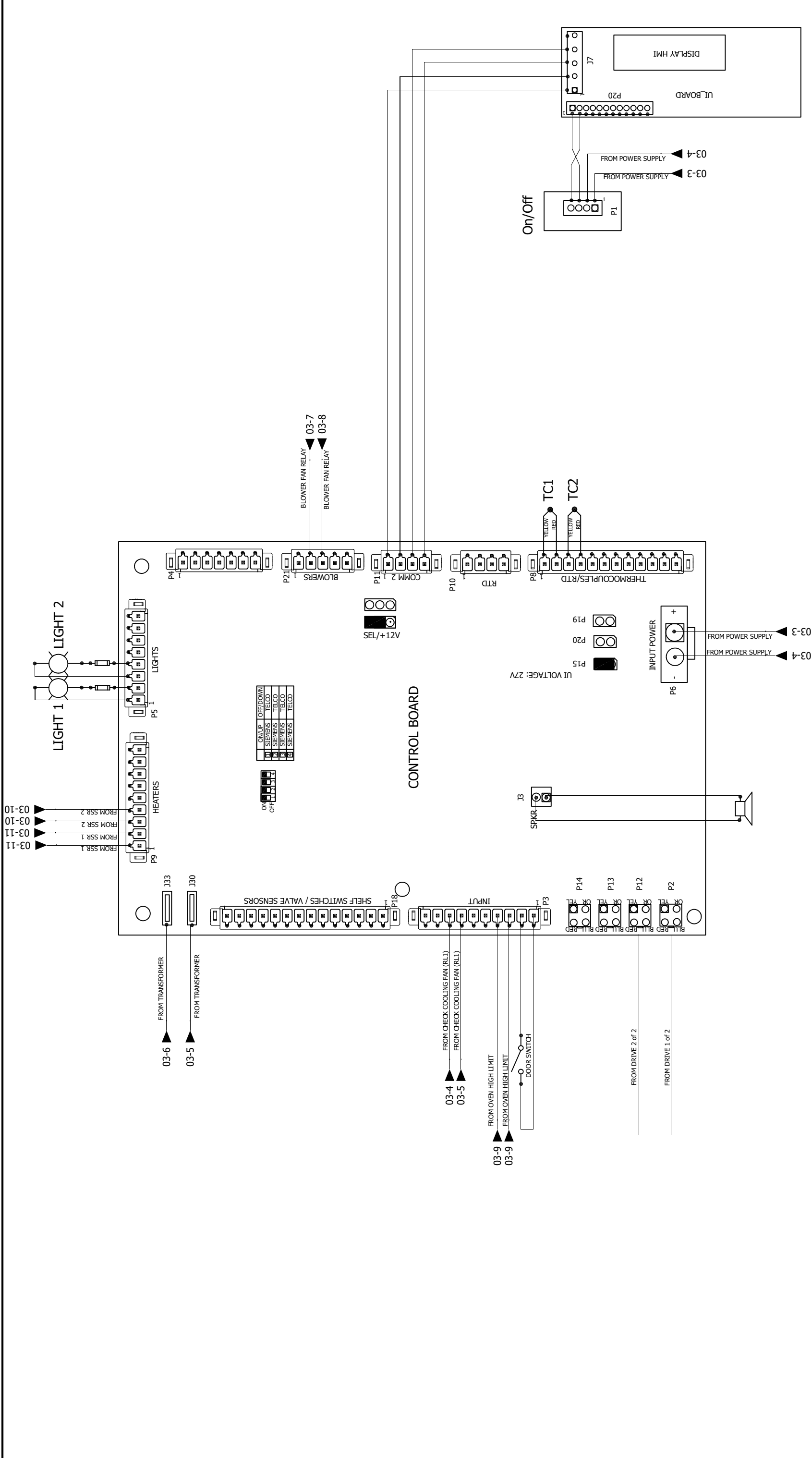

12
11
10
9
8
7
6
5
4
3
2
1

DELUXE CONTROL

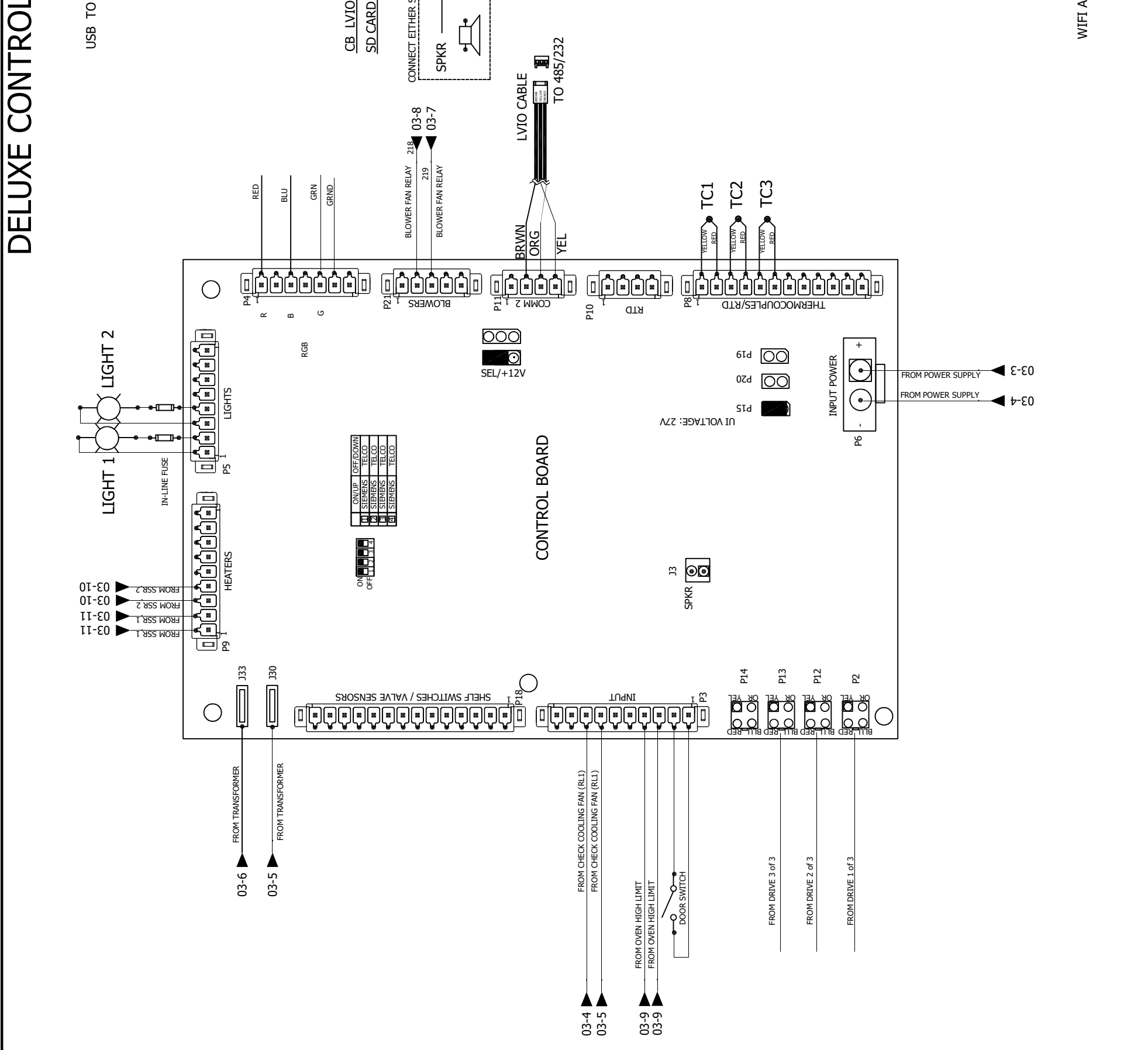
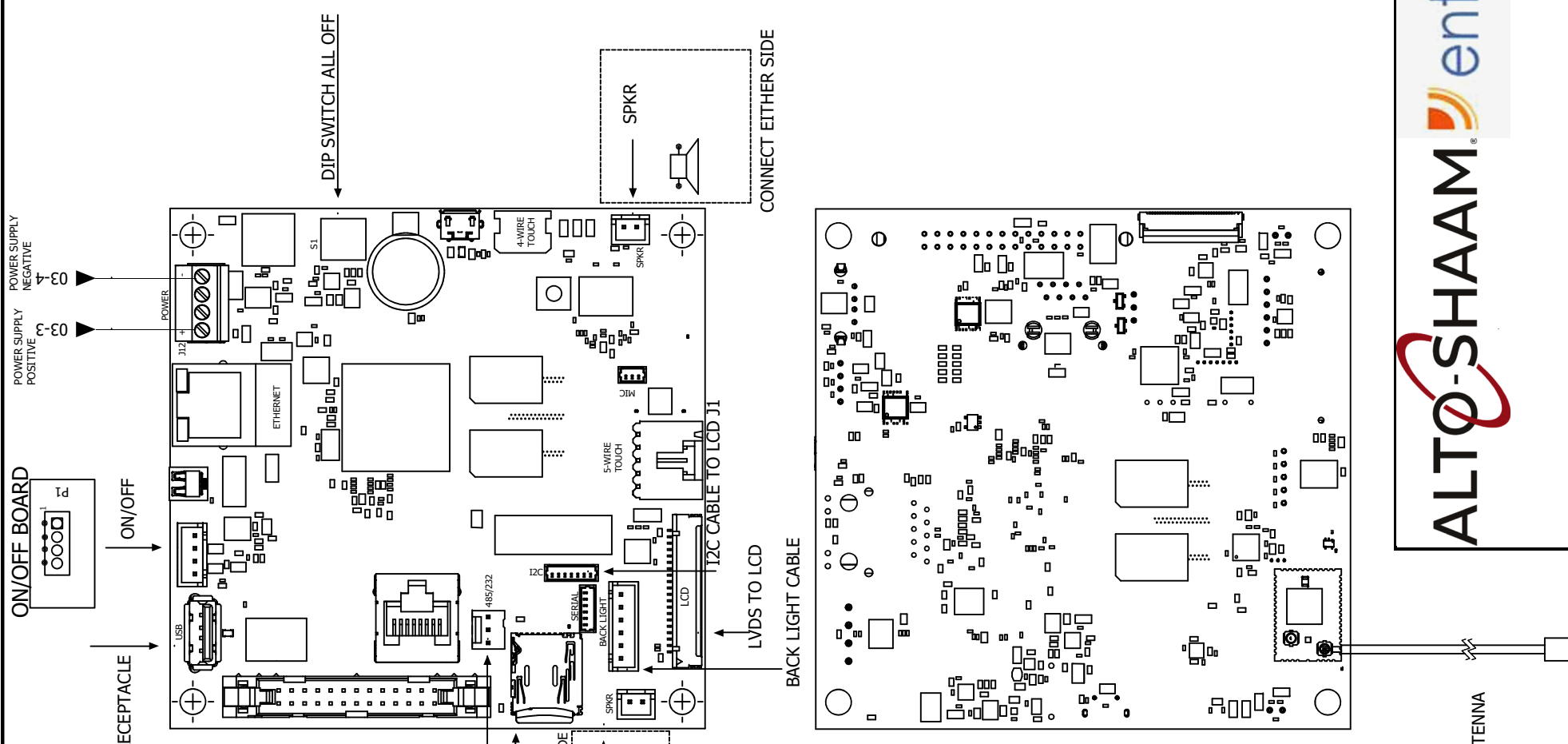
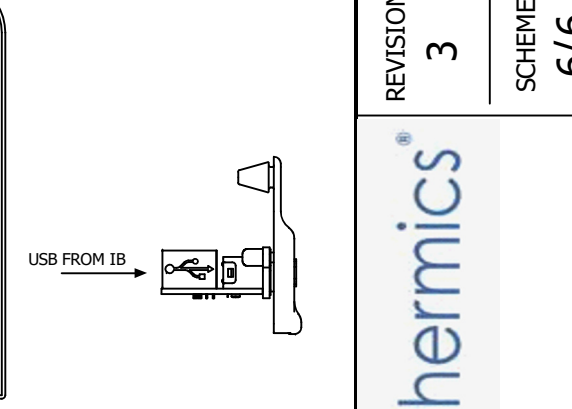
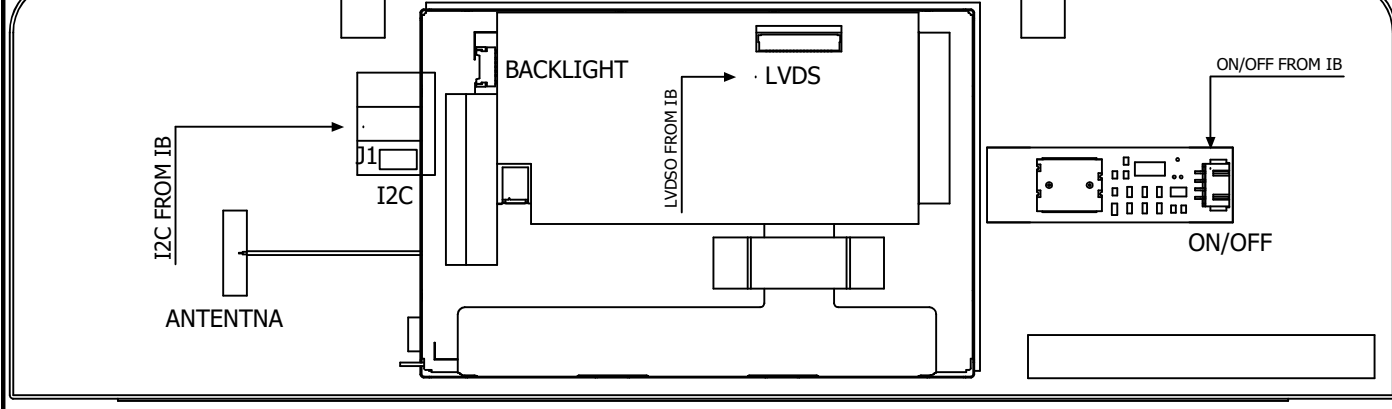

REVISION 3

SCHEME 6/6

Alto-Shaam

77664

WIFI ANTENNA



380-415V 50Hz 3Ph

77665

REV.	DATE	NAME	ECO	CHANGES	REVISION
3	10/23/2019	montev	181383	Remove Top & Bottom motor note, correct COM position.	3
2	7/17/2019	montev	181241	Remove 137ohms resistor P11	PAGE 1/6
1	10/18/2018	montev	731145	Adding RGB P4	Alto-Shaam
0	8/22/2017	montev			
77665 H3 380-415V 50Hz 3Ph					

TABLE OF CONTENTS

MAIN & BRANCH CIRCUIT	PG 03
DRIVE, MOTOR, COOLING FAN	PG 04
SIMPLE CONTROL	PG 05
DELUXE CONTROL	PG 06

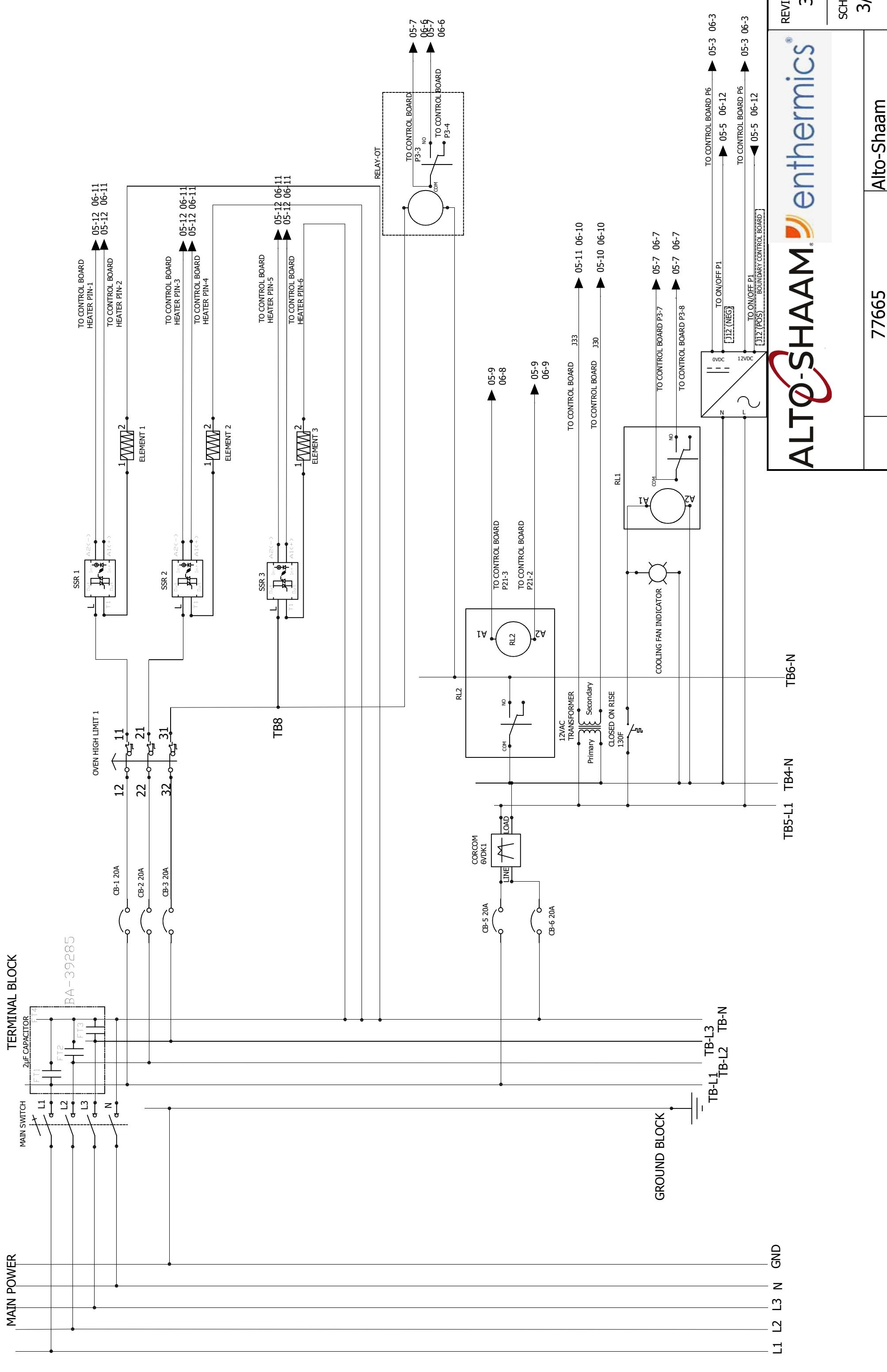

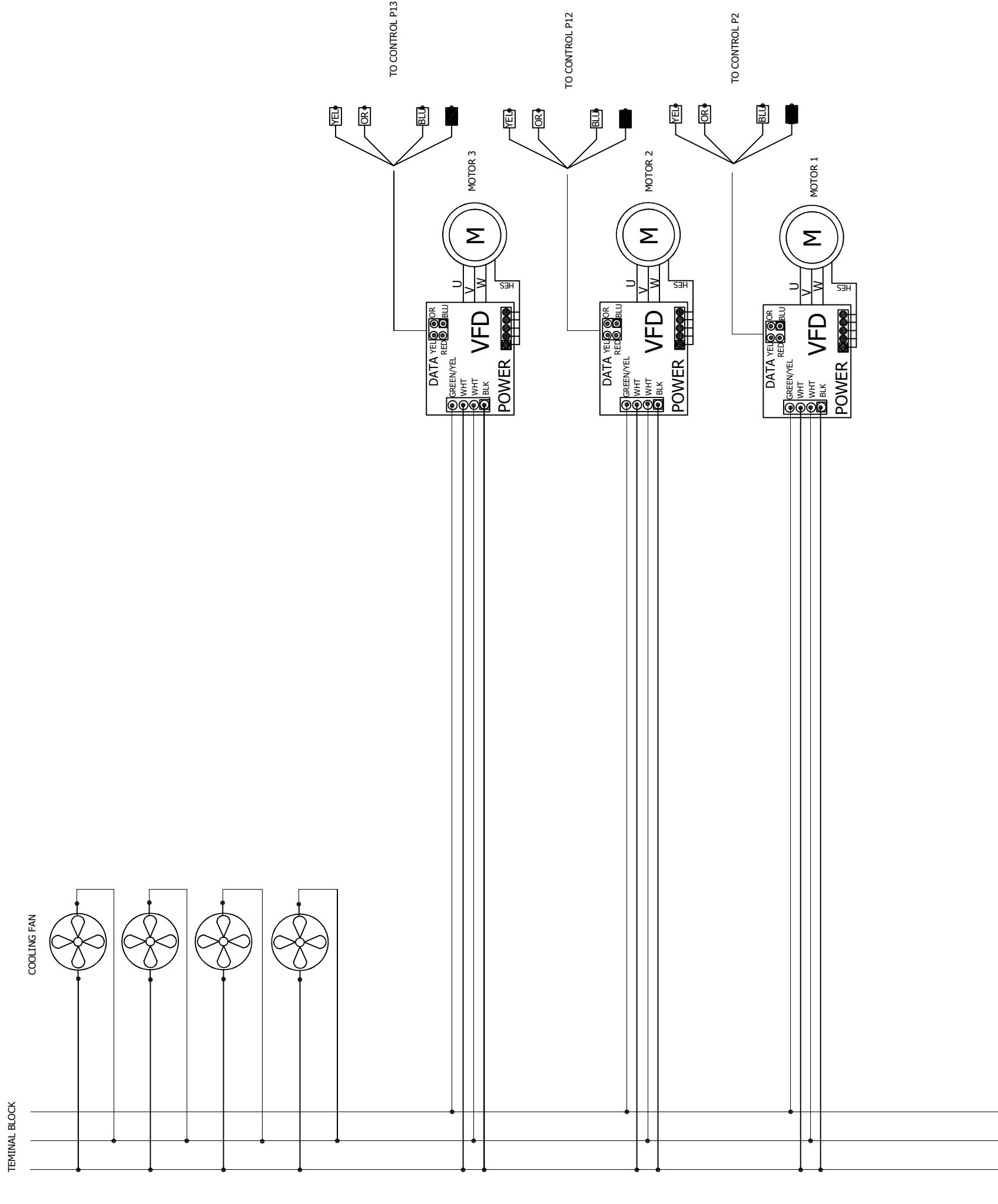

TB5-L1 TB7-GND
TB6-N

12
11
10
9
8
7
6
5
4
3
2
1

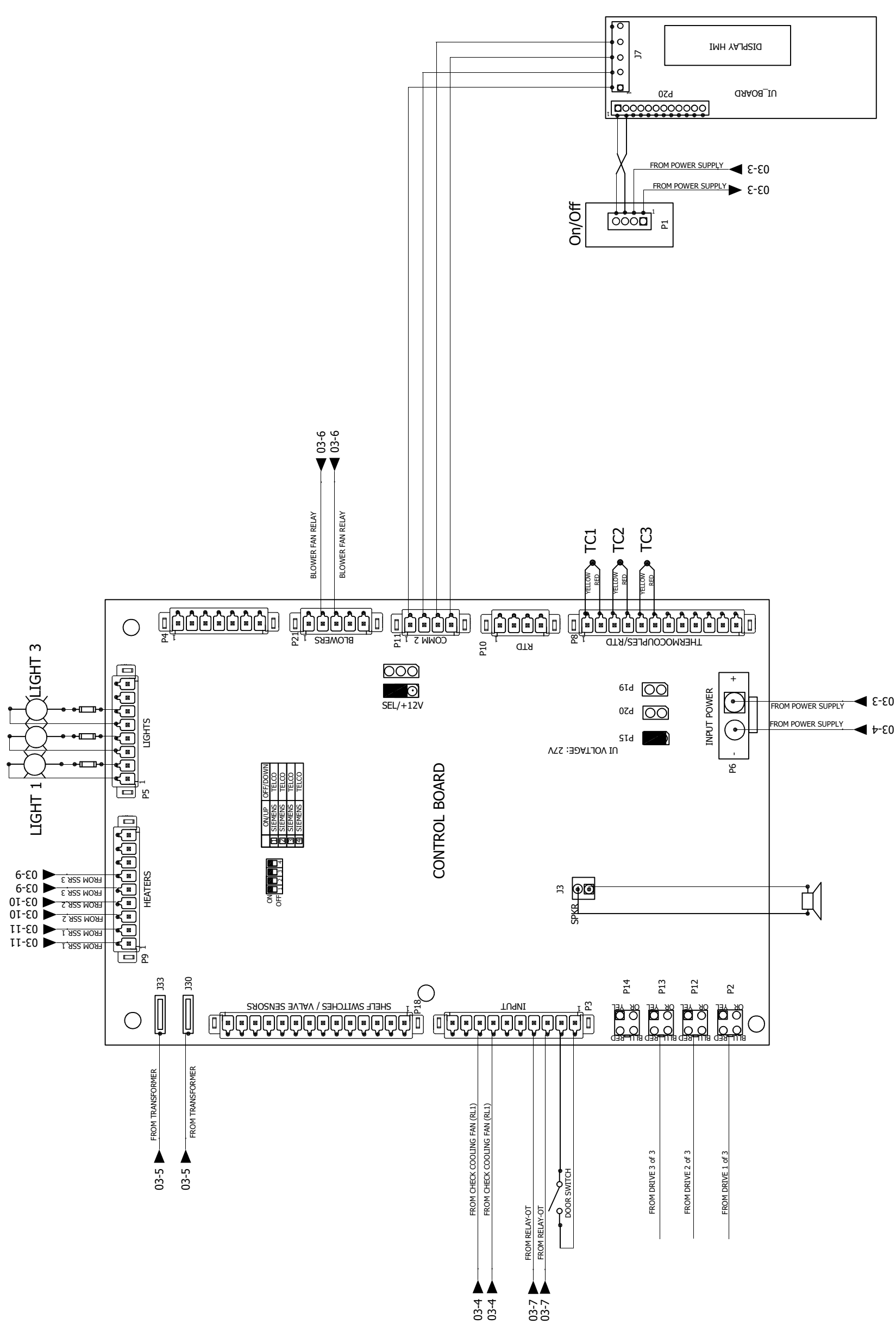

DELUXE CONTROL

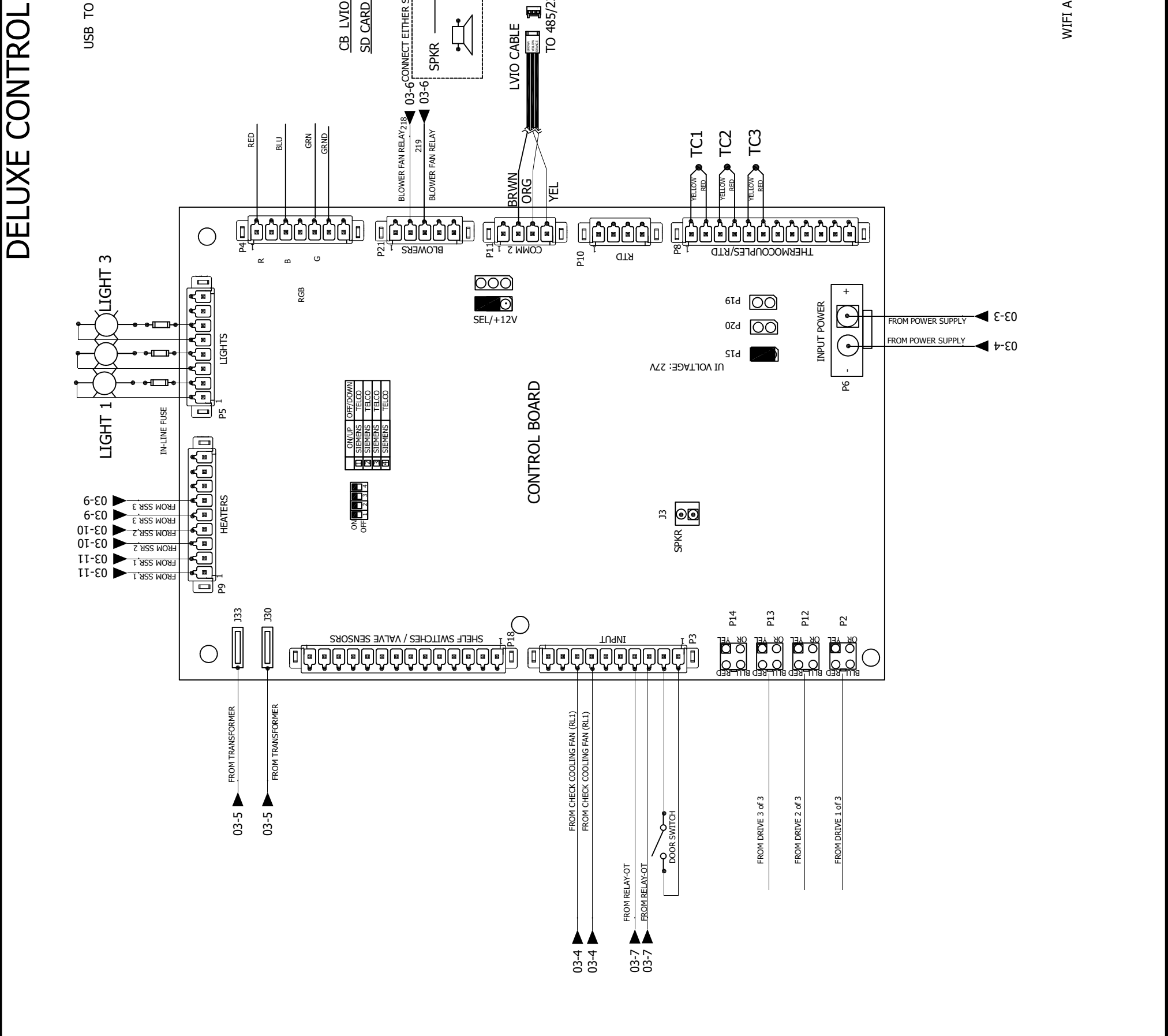
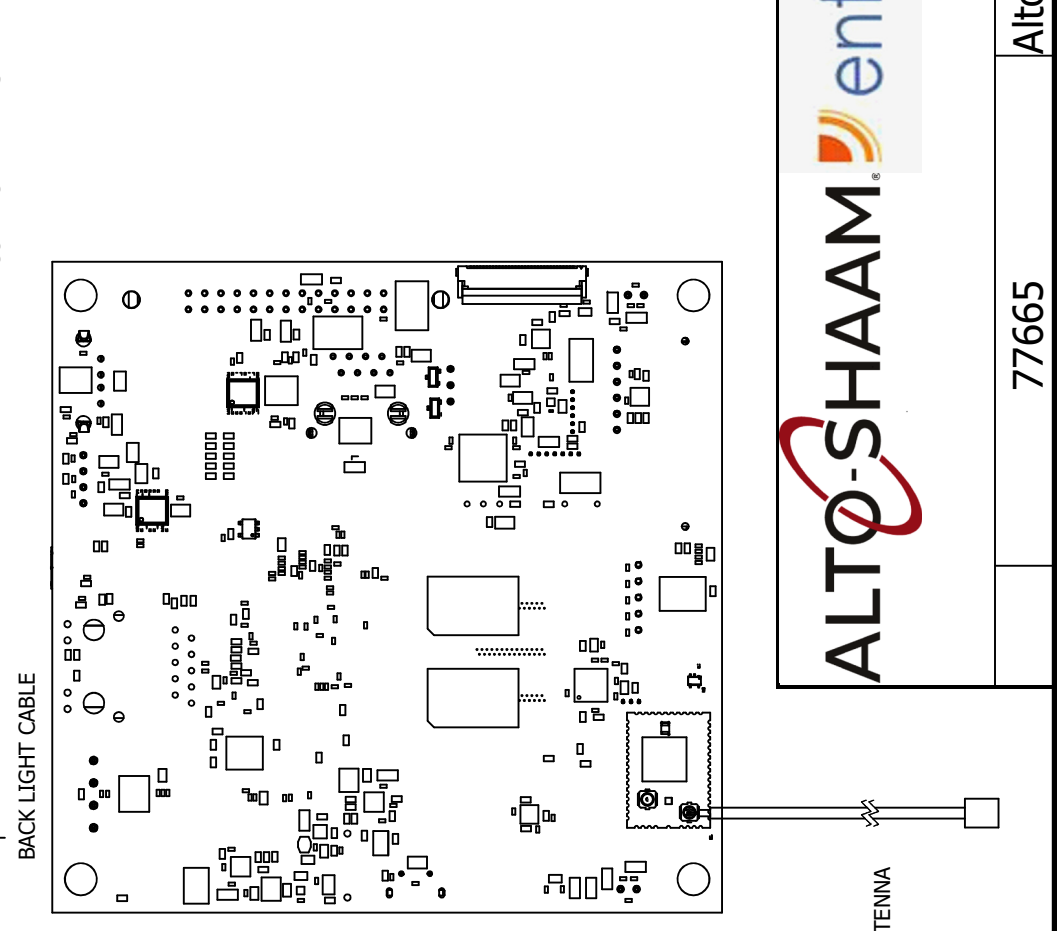
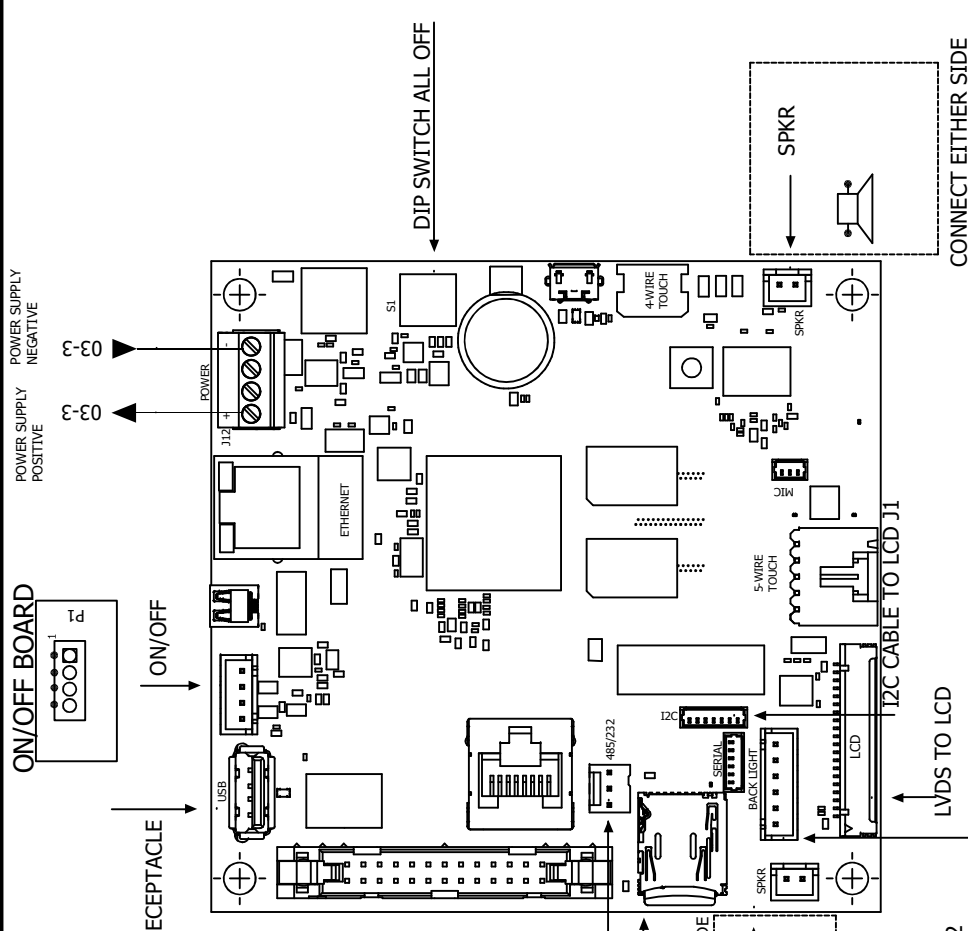
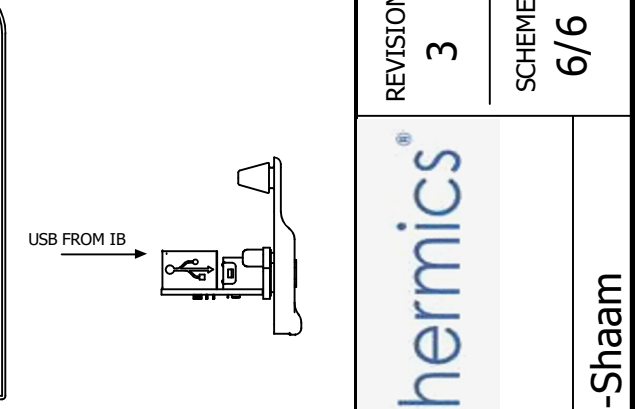
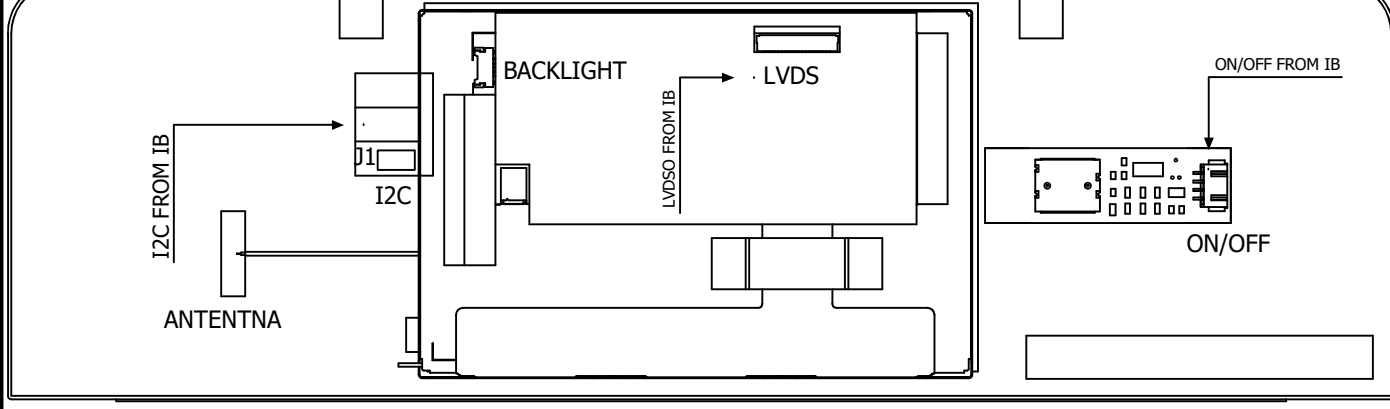

1	ON/UP	OFF/DOWN
2	SIEMENS	TELCO
3	SIEMENS	TELCO
4	SIEMENS	TELCO
5	SIEMENS	TELCO

REVISION 3
SCHEME 6/6

ALTO-SHAAM enthermics

77665 Alto-Shaam

TABLE OF CONTENTS

11	MAIN & BRANCH CIRCUIT	PG 03
10	DRIVE, MOTOR, COOLING FAN	PG 04
9	SIMPLE CONTROL	PG 05
	DELUXE CONTROL	PG 06

12

11

10

9

8

7

6

5

4

3

2

1

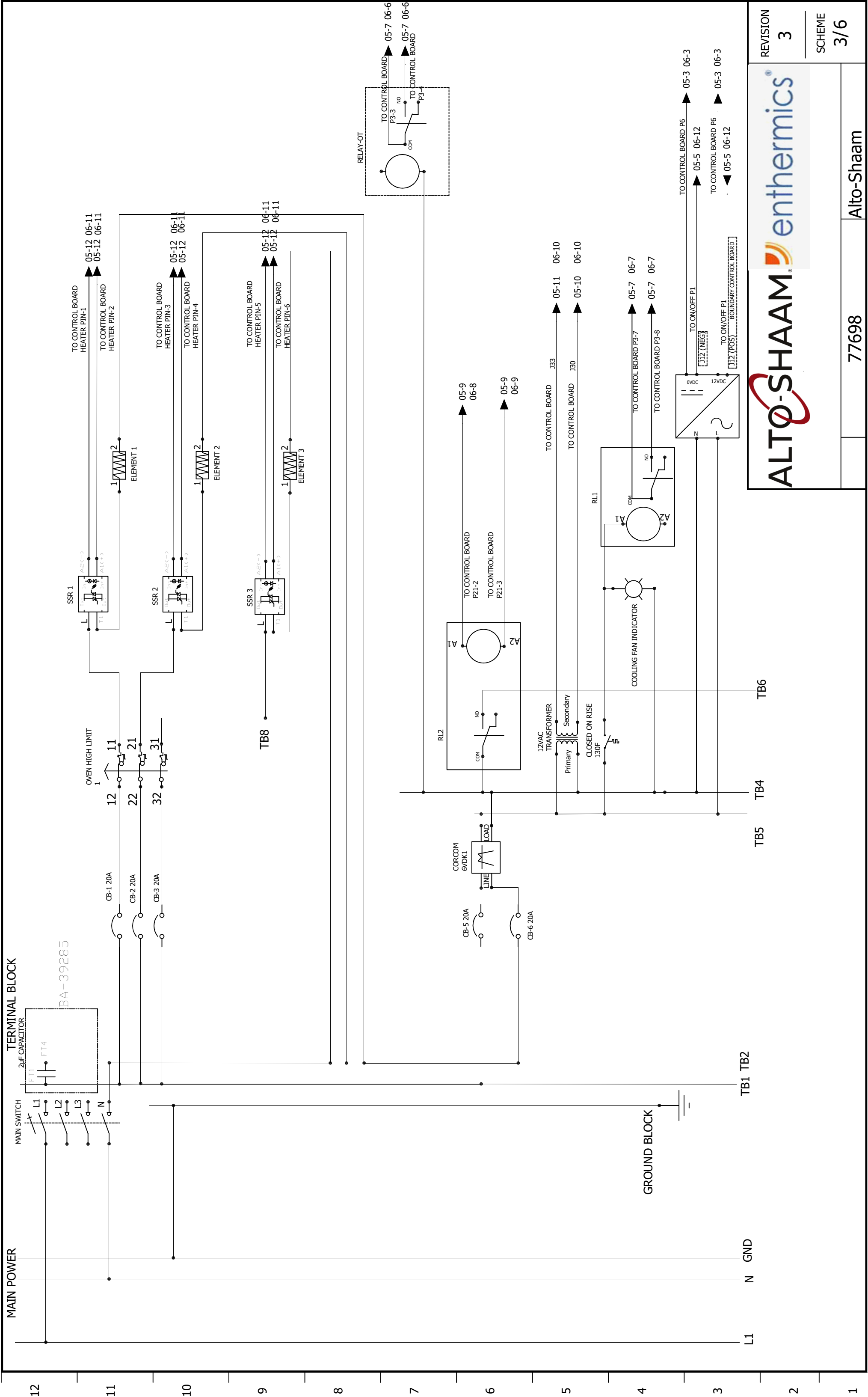

ALTO-SHAAM  enthermics®
 REVISION 3
 SCHEME 3/6
 77698 Alto-Shaam

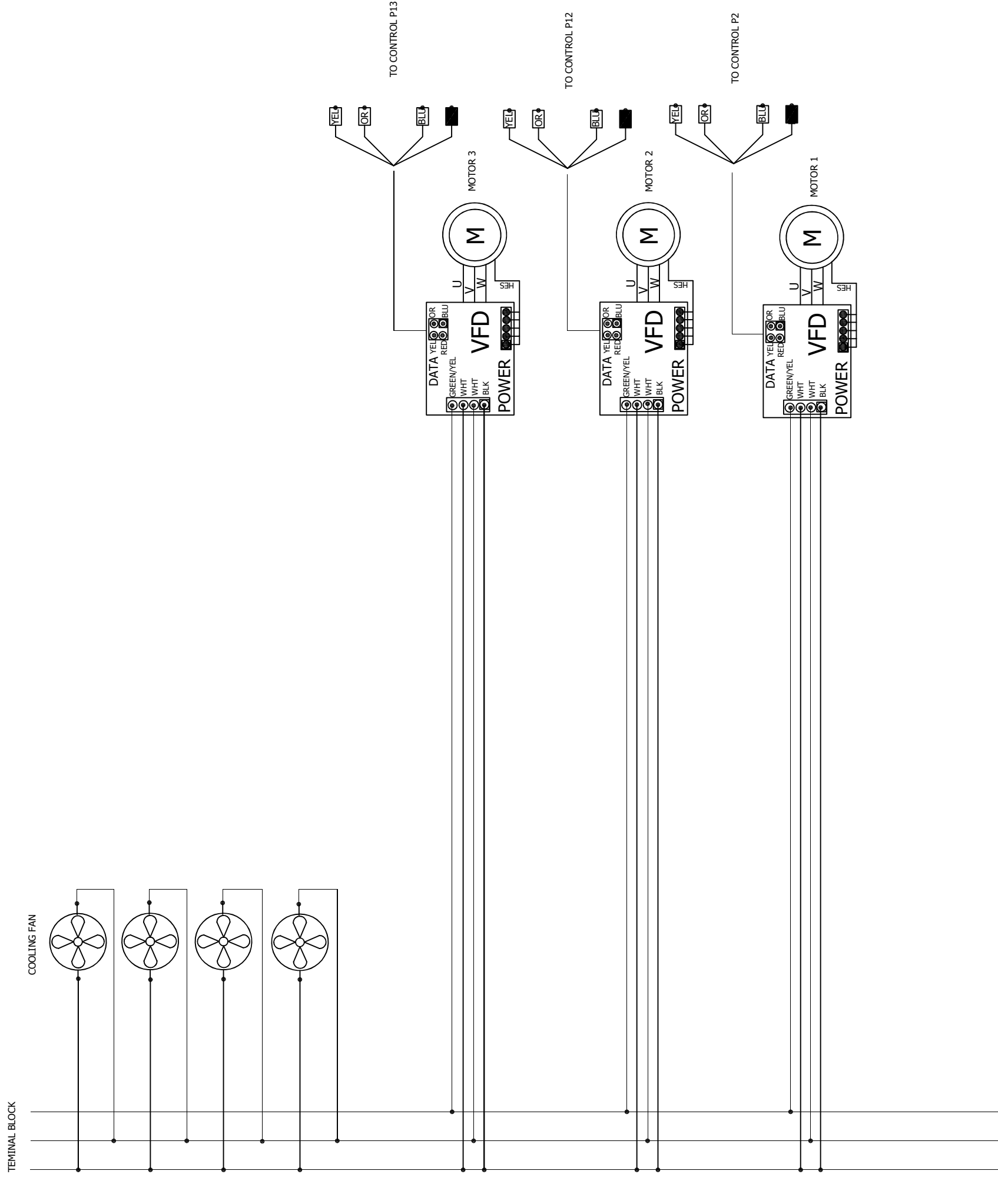

TB5-L1
TB6-N
TB7-GND

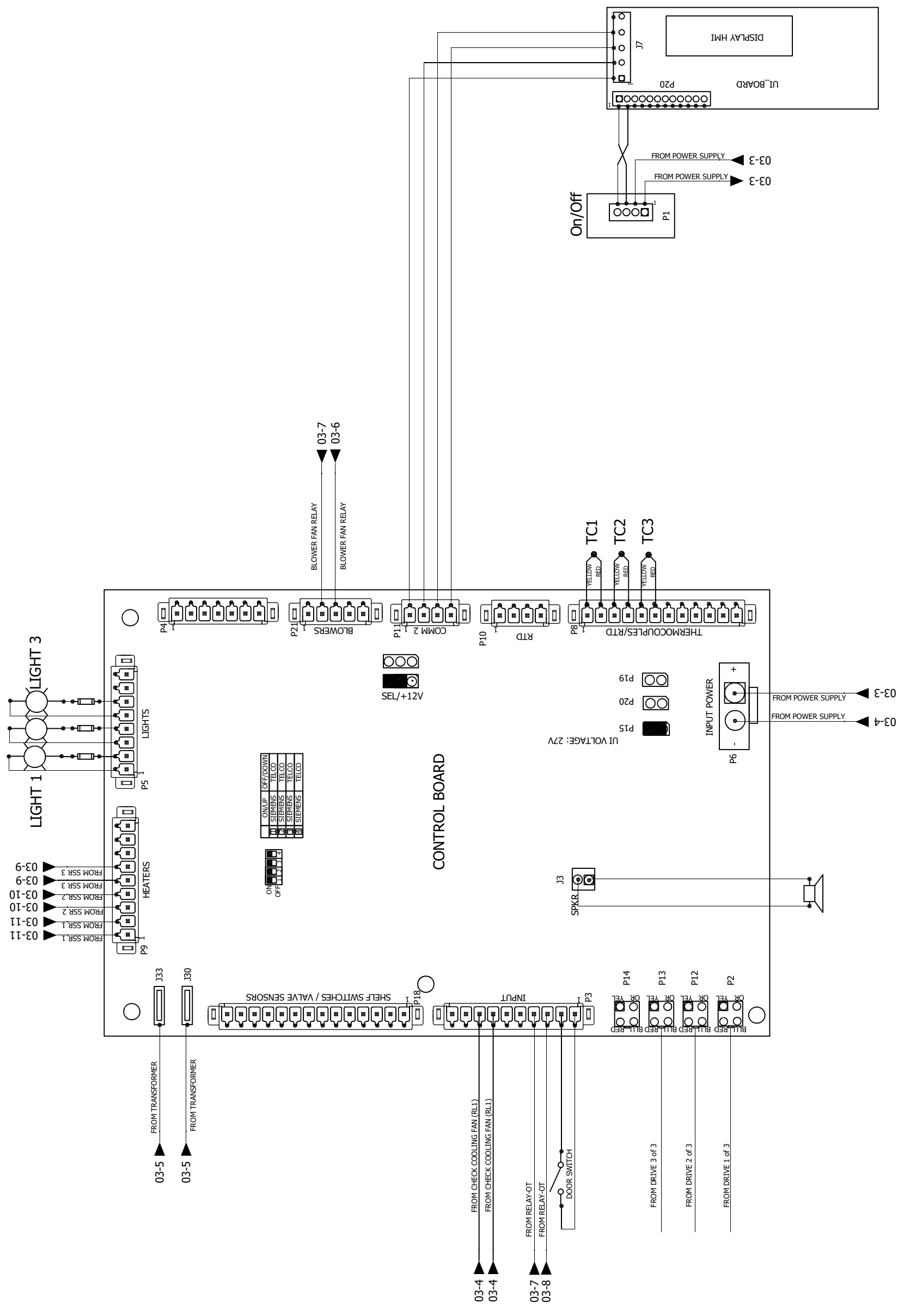

DELUXE CONTROL

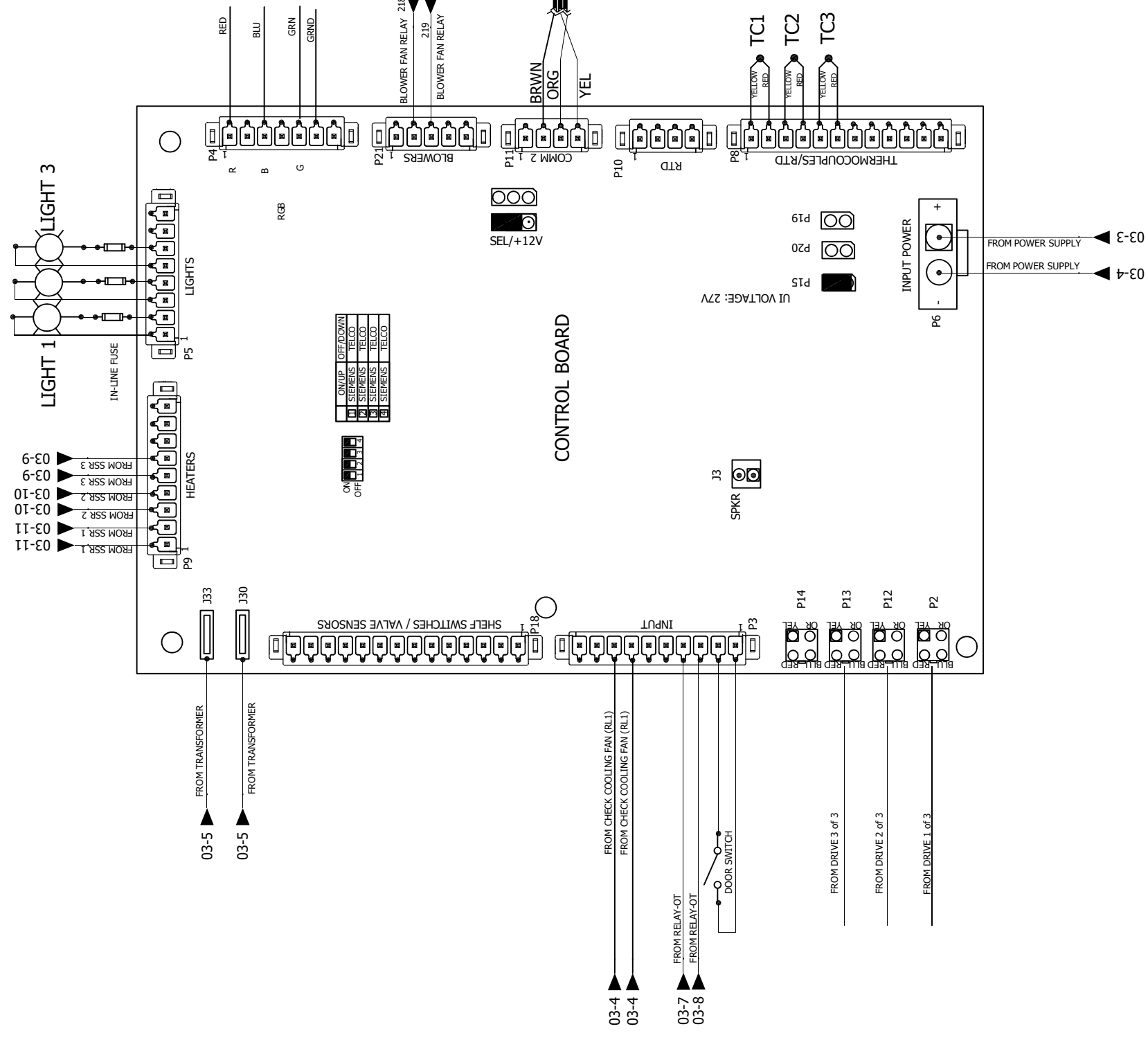

380-415V 3Ph

77701



REV.	DATE	NAME	ECO	CHANGES	REVISION
2	10/23/2019	montev	181383	Remove Top & Bottom motor note, correct COM position.	2
1	10/18/2018	montev	181241	Adding RGB P4 and Cap Touch	PAGE
0	9/20/2017	montev			1/6
77701 H2 380-415V 3Ph					Alto-Shaam

TABLE OF CONTENTS

MAIN & BRANCH CIRCUIT	PG 03
DRIVE, MOTOR, COOLING FAN	PG 04
SIMPLE CONTROL	PG 05
DELUXE CONTROL	PG 06

TERMINAL BLOCK

12

11

10

9

8

7

6

5

4

3

2

1

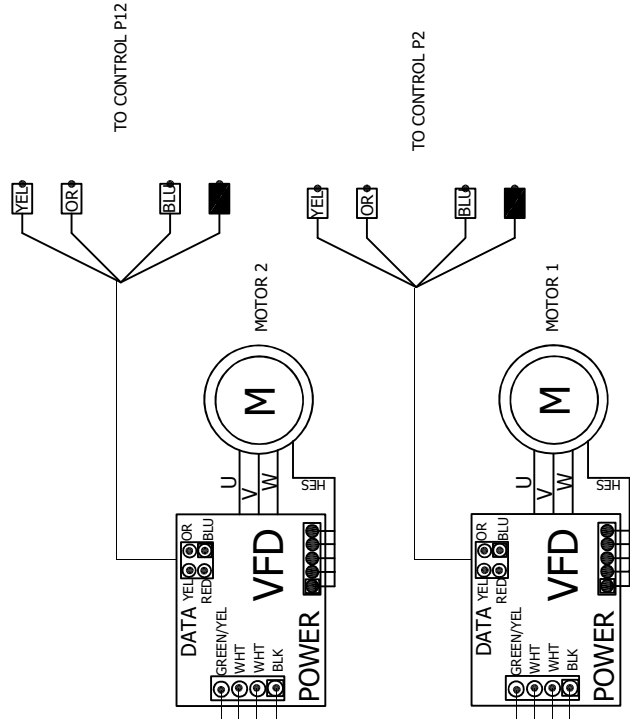
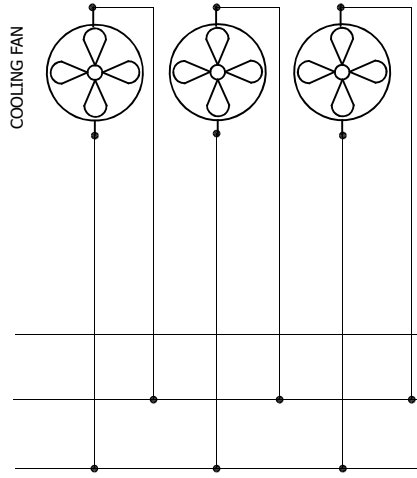

TB5-L1 TB7-GND
TB6-N

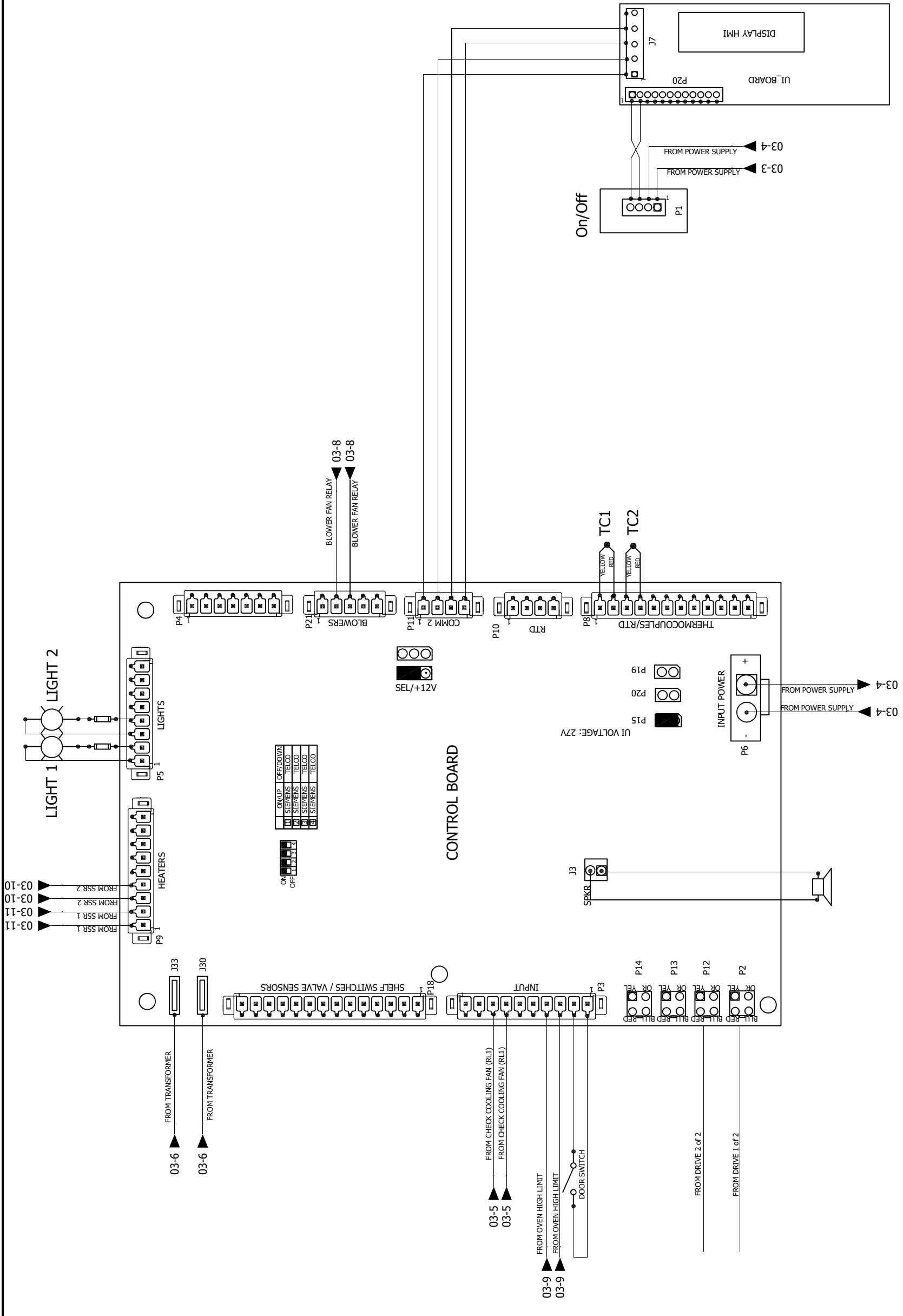

12
11
10
9
8
7
6
5
4
3
2
1

DELUXE CONTROL

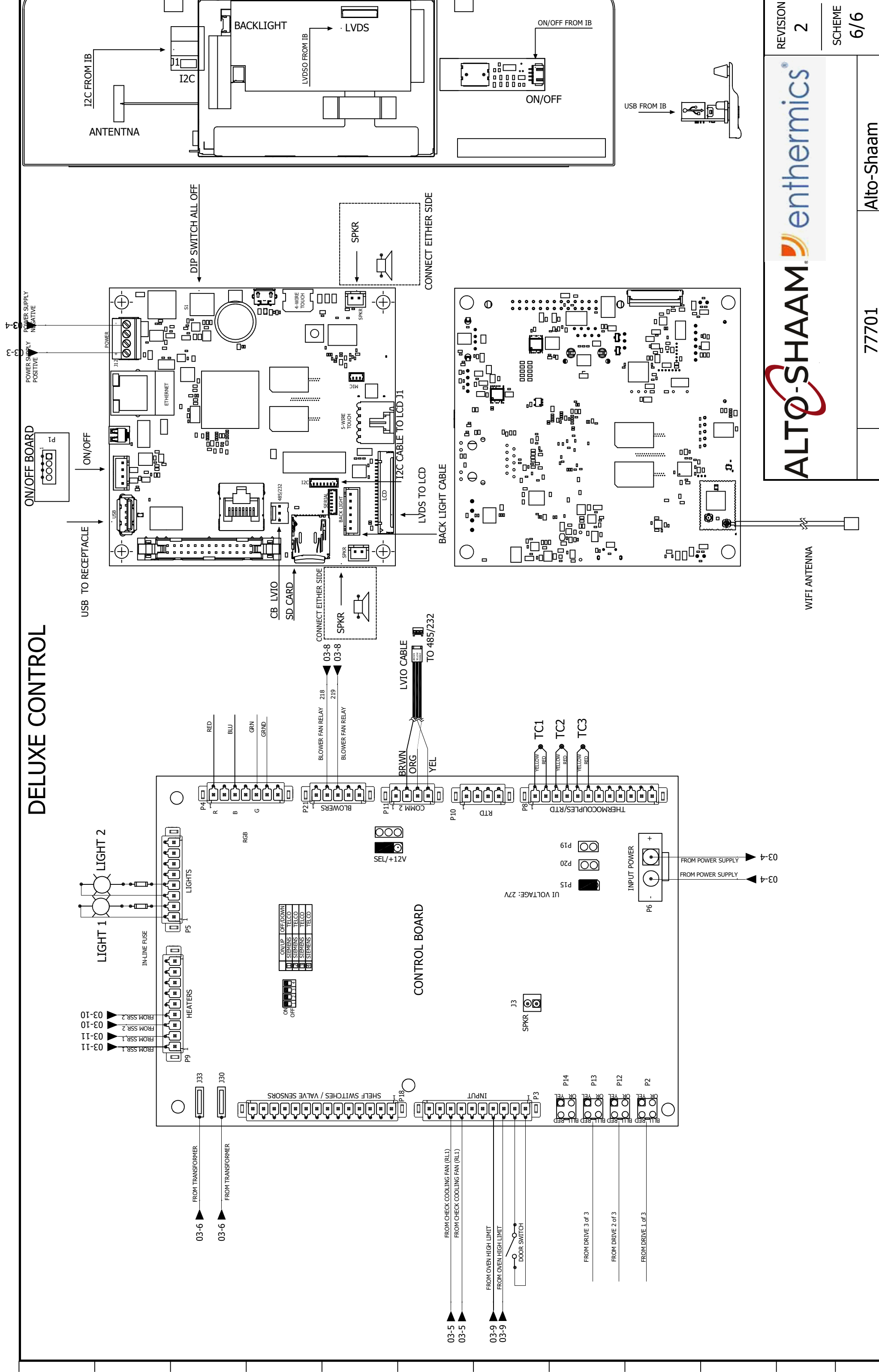

208-240V 3Ph

77706



REV.	DATE	NAME	ECO	CHANGES
7	10/23/2019	montev	181383	Remove Top & Bottom motor note, correct COM position.
6	7/17/2019	montev	181241	Remove 137ohms resistor P11
5	4/24/2019	montev	181074	CFA Specific WD Reference 77728
4	10/18/2018	montev	731145	RGB P4 & ECR 180719
3	5/30/2018	montev	180363	Adding CFA Control & Antenna
CHANGES				
77706				
H3				
208-240V 3Ph				
				Alto-Shaam
				REVISION 7
				PAGE 1/6

TABLE OF CONTENTS

MAIN & BRANCH CIRCUIT	PG 03
DRIVE, MOTOR, COOLING FAN	PG 04
SIMPLE CONTROL	PG 05
DELUXE CONTROL	PG 06

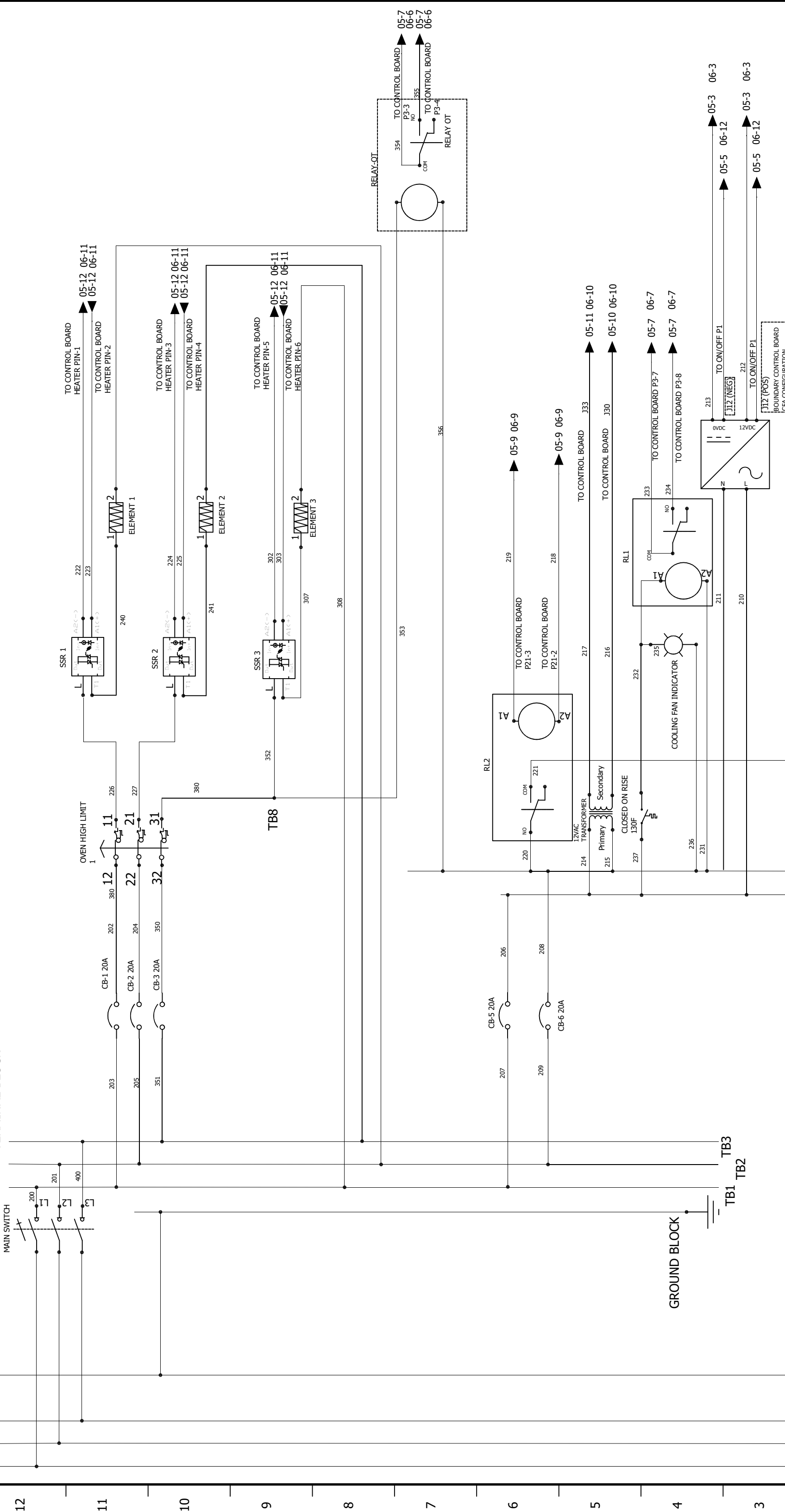



ALTO-SHAAM



enthermics

REVISION
7

SCHEME
3/6

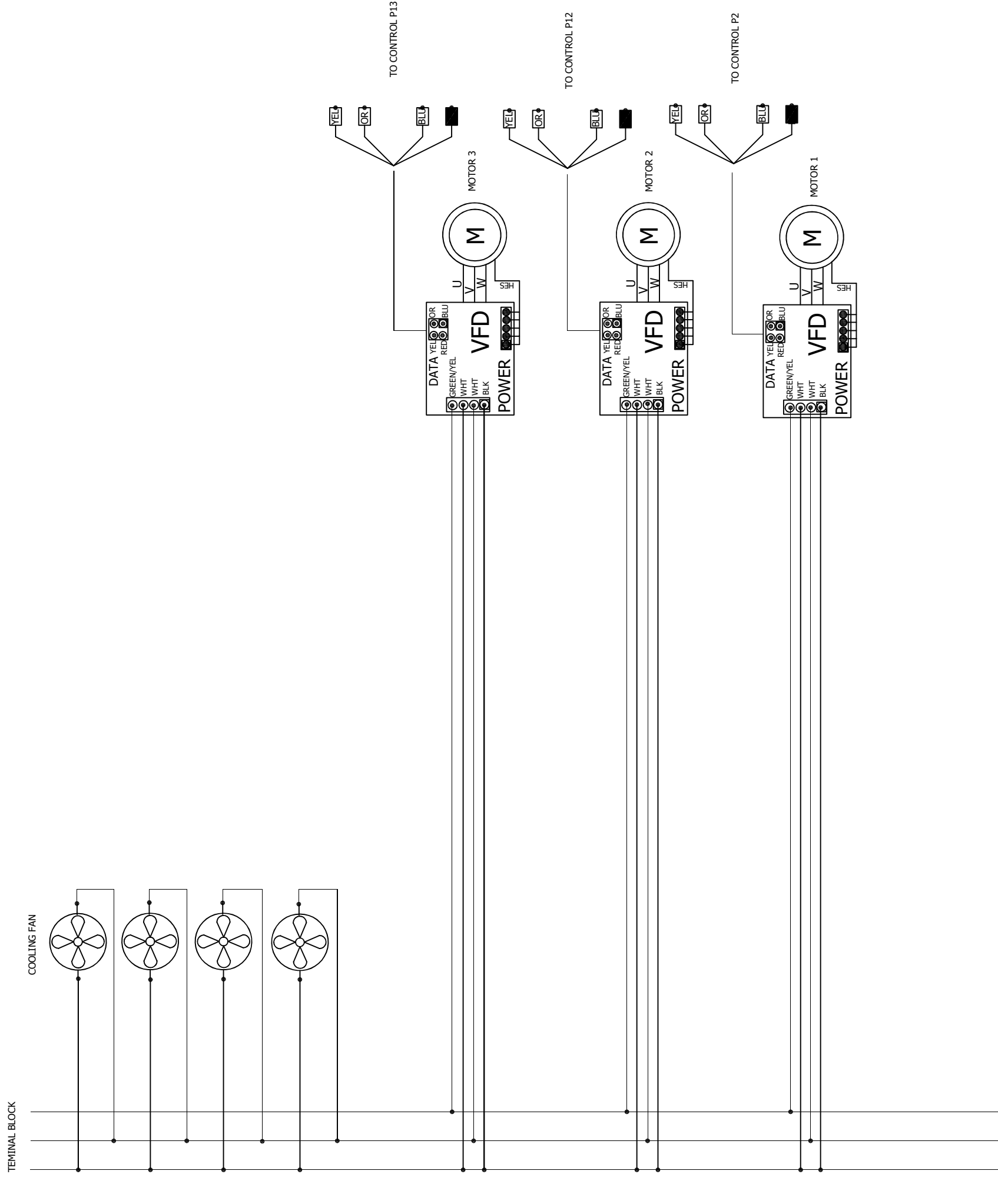

TB5-L1 TB7-GND
TB6-L2

GENERAL CONTROL

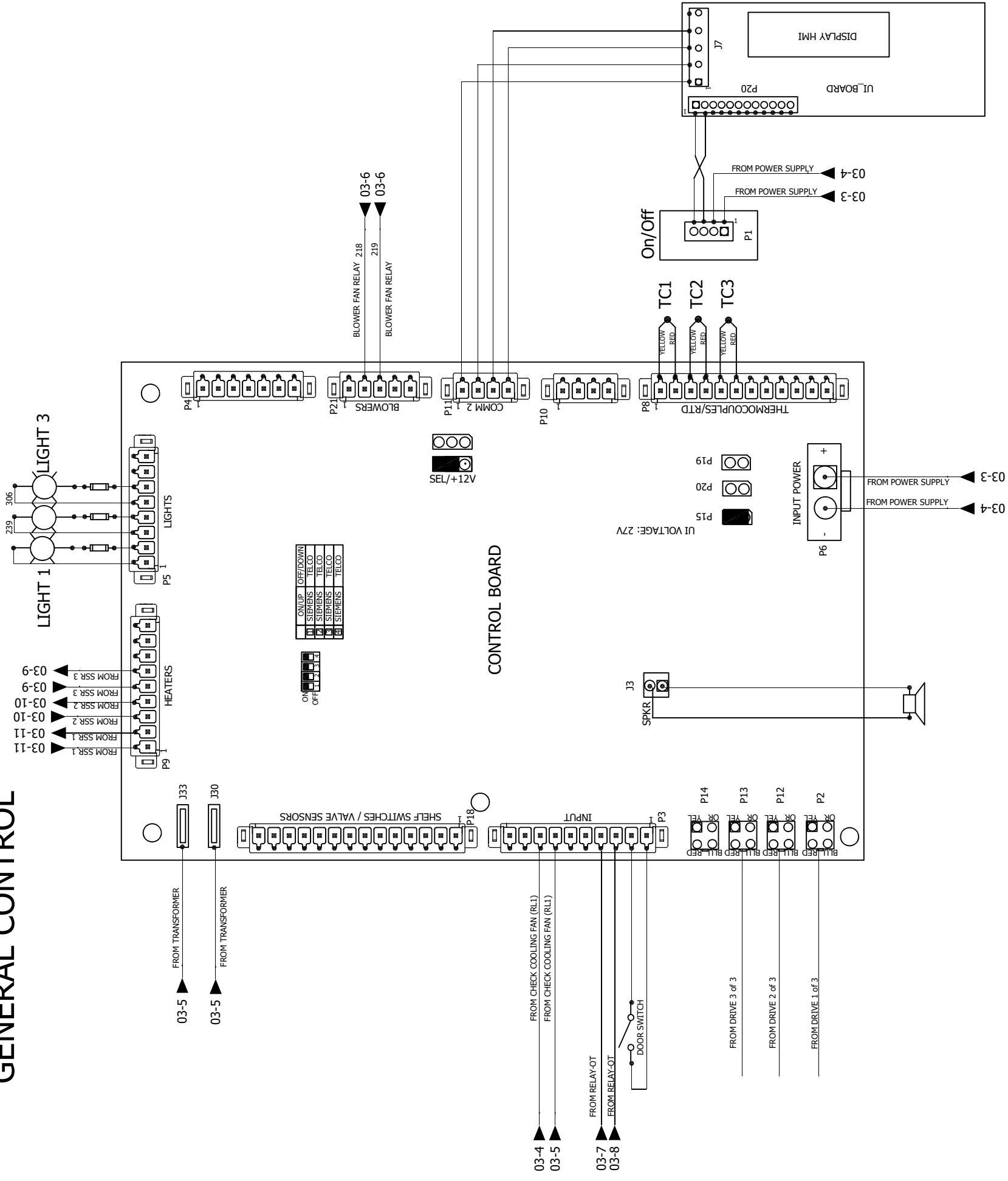

DELUXE CONTROL

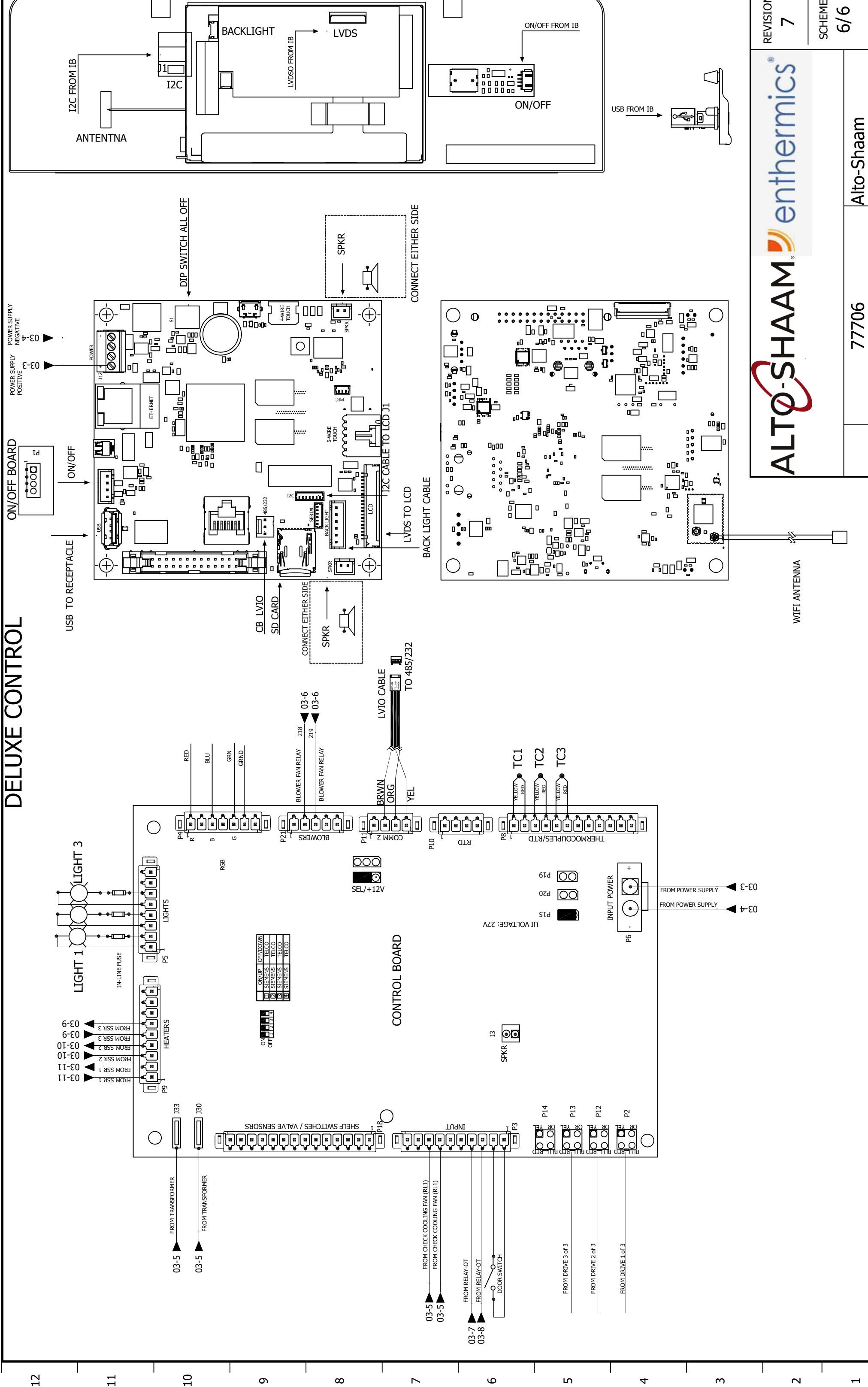



ALTO-SHAAM ASIA
Shanghai, China
Phone +86-21-6173 0336

ALTO-SHAAM CANADA
Concord, Ontario Canada
Toll Free Phone 866-577-4484
Phone +1-905-660-6781

**ALTO-SHAAM CENTRAL
& SOUTH AMERICA**
Miami, FL USA
Phone +1-954-655-5727

**ALTO-SHAAM MIDDLE EAST
& AFRICA**
Dubai, UAE
Phone +971 4 321 9712

ALTO-SHAAM MEXICO
Phone +52 1 477-717-3108

ALTO-SHAAM FRANCE, L.L.C.
Aix en Provence, France
Phone +33(0)4-88-78-21-73

ALTO-SHAAM GMBH
Bochum, Germany
Phone +49(0)234-298798-0

ALTO-SHAAM RUSSIA
Moscow, Russia
Phone +7-903-793-2331

ALTO-SHAAM.

Menomonee Falls, WI 53052-0450, U.S.A.
Telephone 800-558-8744 | +1-262-251-3800 | alto-shaam.com