

# SERVICE & INSTRUCTION OWNER'S MANUAL



## DECK OVENS

**SRPO-48G**

**SRPO-60G**

**SRPO-72G**

**IMPORTANT INSTRUCTIONS FOR OVEN  
INSTALLATION, OPERATION AND  
MAINTENANCE**

MVP GROUP LLC, 12000 BISCAYNE BLVD., SUITE 108, MIAMI, FL 33181

TEL: 786-600-7554 FAX: 786-661-4100

MVP GROUP CORP, 5659 ROYALMOUNT, MONTREAL, QC CANADA H4P 2P9

TEL: 514-737-9701 FAX: 514-342-3854

[WWW.MVPGROUPCORP.COM](http://WWW.MVPGROUPCORP.COM)

**NOTICE: WHEN THIS APPLIANCE IS INSTALLED WITH CASTERS, IT MUST BE INSTALLED WITH THE CASTERS SUPPLIED, A CONNECTOR COMPLYING WITH EITHER ANSI Z21.69 OR CAN/CGA-6.16. AND A QUICK-DISCONNECT DEVICE COMPLYING WITH EITHER ANSI Z21.41 OR CAN 1-6.9. IT MUST ALSO BE INSTALLED WITH A RESTRAINING MEANS TO GUARD AGAINST TRANSMISSION OF STRAIN TO THE CONNECTOR , AS SPECIFIED IN THE APPLIANCE MANUFACTURER'S INSTALLATION INSTRUCTIONS.**

**IN THE COMMONWEALTH OF MASSACHUSETTS THIS APPLIANCE MUST BE INSTALLED UNDER AN EXHAUST HOOD AND MUST BE INTERLOCKED WITH THE GAS SYSTEM AND COMPLY WITH STATE PLUMBING CODES AND INSTALLED BY A LICENSED PLUMBER OR GAS FITTER.**

## **IMPORTANT FOR YOUR SAFETY**

Installation and service must be performed by a qualified installer, service agency or the gas supplier.

### **WARNING**

This appliance is only for professional use and shall be used only by qualified people. All parts that have been protected by the manufacturer or his agent must not be adjusted by the end user.

Improper installation, adjustment, service or maintenance can cause property damage, injury or death. Read the installation, operating and maintenance instructions thoroughly before installing this equipment.

## **WHAT TO DO IF YOU SMELL GAS**

- Do not try to light any appliance.
- Do not touch any electrical switch; do not use any phone in your building.
- Immediately call your gas supplier from a neighbor's phone. Follow the gas supplier's instructions.
- If you cannot reach your gas supplier, call the fire department.

## **FOR YOUR SAFETY**

Do not store or use gasoline or flammable vapors or liquids in the vicinity of this or any other appliance.

**IN THE EVENT OF A POWER FAILURE DO NOT ATTEMPT TO OPERATE THIS DEVICE. SHUT OFF POWER.**

# IMPORTANT INSTALLATION INSTRUCTIONS

During transportation due to vibration it is possible that leaks may occur.

Please remove front panel of oven and verify that there are no leaks of gas on the joints (fittings) between aluminum tubing and the valve to the pilot and the fitting of the thermostat to the valve.

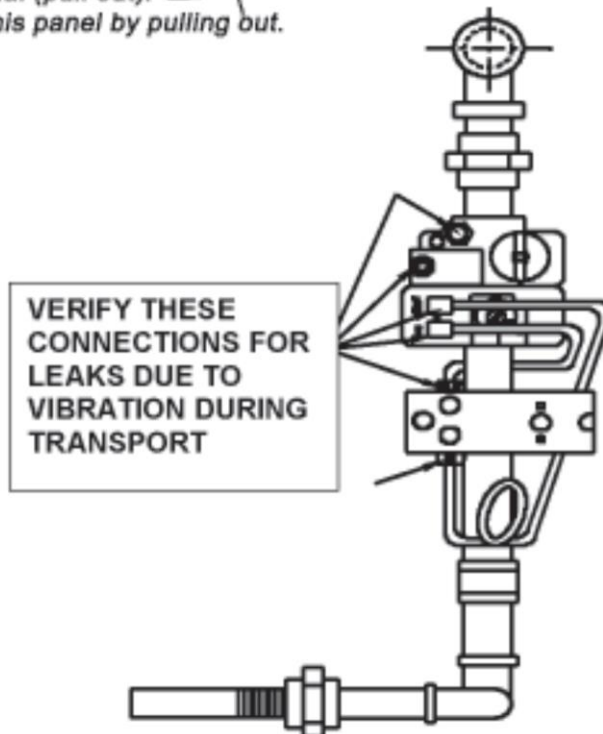
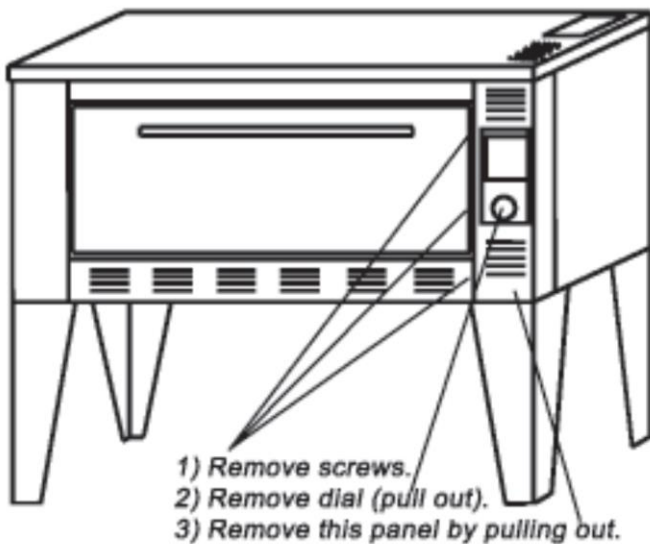

THE CONTROL SYSTEM ON YOUR APPLIANCE IS A



**UNITROL**  
7000GO(R) & 7000GO(R)HC  
GAS OPERATED  
CONTROL VALVE

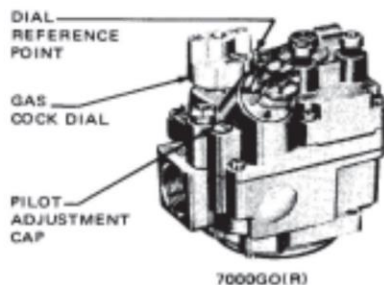

7000GO(R)

### TO START OPERATION:

1. Set the room thermostat to the lowest temperature setting, or "OFF."
2. Partially depress and turn control Gas Cock Dial to "OFF" position.
3. Wait five minutes to allow gas which may have accumulated in the main burner compartment to escape.
4. Turn Gas Cock Dial to "PILOT" position.
5. Depress Gas Cock Dial and light Pilot. Hold in depressed position for about 1/2 minute.  
Note: Sufficient time must be allowed for a proper size pilot flame to heat the thermocouple and hold the safety magnet in a locked-up position. Also, time must be allowed for air to escape from the lines during the first operation.
6. Release Dial and turn to full "ON."
7. Reset Room Thermostat.

### INSTALLER NOTE:

Please leave these lighting instructions with unit.  
**DO NOT REMOVE.**

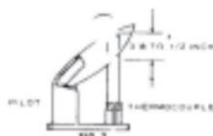

### PILOT BURNER ADJUSTMENT:

1. Remove Pilot Adjustment Cap.
2. Adjust pilot key to provide properly sized flame.
3. Replace Pilot Adjustment Cap.

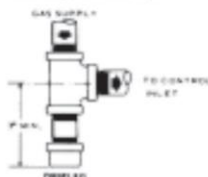

## C4200 (FD) COMMERCIAL GAS THERMOSTAT

Individual models of the VC4200 series are available for specific applications. These thermostats are used on ovens, fryers, sterilizers and similar equipment.

Throttle models provide snap action to "off" for low temperature settings and throttling main valve action for higher temperature settings.

Throttling only models have a constant by-pass and maintain a minimum flame on the burner when the unit is in operation.

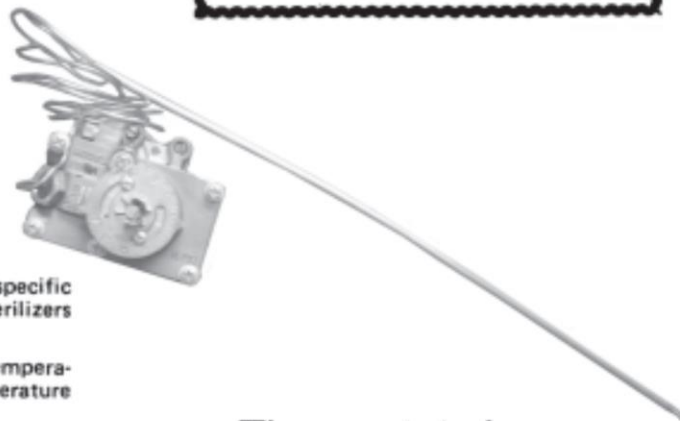

Thermostat shown  
RB4200503

### WARNING

1. Shut off gas and electricity before starting installation or service. Turn back on to test or operate.
2. Installation and servicing of gas appliances and controls must only be performed by qualified personnel. After installation or servicing, test manual valve, pressure regulation (if so equipped), and automatic safety shut off valve for proper operation.
3. A drip leg should be provided in the supply line to the control.
4. Leak test with a soap solution after installation or servicing with main burner on. Coat pipe and tubing joints, gasket etc. with soap solution. Bubbles indicate leaks.
5. **DO NOT** use this control if it has been exposed to water corrosion through immersion, dripping, etc. It may be damaged and must be replaced.
6. **DO NOT** insert any object other than suitable pipe or tubing in the inlet or outlet of this control. Internal damage may occur and result in a hazardous condition.
7. **DO NOT** connect appliance before pressure testing gas piping. Damage to gas valve may result.
8. **DO NOT** grip control body with a pipe wrench or vise. Damage may result causing gas leakage. Use inlet or outlet bosses, or special body wrench.
9. **DO NOT** use Gas Cock Dial to adjust gas flow. Turn dial to full "ON".
10. Dials must only be operated by hand. **DO NOT** use pliers, wrenches or other tools to turn dials.
11. In changing from natural to L.P. gas, or vice versa, regulator assembly (if so equipped), burner and pilot orifices must be changed.
12. When using L.P. gas caution must be taken to ensure that no raw gas is present in the surrounding area before attempting to put appliances into operation, or relighting pilot.
13. In case of failure of gas valve to shut off, **DO NOT** shut off electrical power; turn off gas supply allowing circulating pump (if so equipped) to continue running until system has cooled.
14. Keep all combustible materials away from gas appliance. **DO NOT** allow lint or dust to collect in burner area.

# SAVE THESE INSTRUCTIONS FOR FUTURE USE

## GENERAL

Read these instructions and keep them for future reference. Before installing the oven, consult your local building authority and obtain a building permit if necessary. Do not modify or alter the construction of the oven or any of its components. Install the oven as described in these instructions. Use only Sierra components. Failure to do so will void the Certification approvals and the warranty of this oven.

## PURCHASER'S RESPONSIBILITY

1. To see that the gas and electric services for the oven are installed on site in accordance with the manufacturer's specifications.
2. To unload, uncrate and install the oven in its proper location in accordance with the Installation Operation Manual.
3. To see that the gas and electric services are connected properly by a qualified installer of your choice. All such connections must be in accordance with applicable Code requirements.
4. To arrange for **inspection** and **operation check-out** by an authorized service technician as described below.
5. **Do not** attempt to operate the oven until connection of utility service has been fully inspected by an authorized service technician
6. The warranty shall not apply if the ovens are started up and operated prior to the utilities and oven being inspected and checked out by an authorized service technician

## INSTALLATION CODES AND STANDARDS:

This Gas-Fired Oven complies with the National Standards of Canada and United States "CSA 1.8 / ANSI Z83.11, Gas Food Service Equipment and NSF/ANSI 4, Commercial Cooking, Rethermalization, and Powered Hot Food Holding and Transport Equipment. It is certified by INTERTEK and bear the cETLus and ETL sanitation certification marks.

This Gas-Fired Oven must be installed in accordance with local codes, if any; if none, follow the latest revision of CAN/CSA B149.1 (Canada) or ANSI Z223.1/NFPA54 (USA) Installation codes, as applicable.

## GAS PIPING: OVENS ARE SUPPLIED WITH GAS CONNECTION THREADED TO ISO-7.

**CAUTION:** The available gas pressure should be within the limits shown in the SPECIFICATIONS section. Excessive pressure will damage Combination Valve and Regulator. If the supply pressure exceeds the 14.0" w.c. (50 MBAR) maximum, a suitable intermediate main regulator must be installed ahead of the Main Manual Shut-Off Valve.

- The burner gas supply piping should branch off from the main line as close to the gas meter as possible. Do not connect to the bottom of an horizontal section. Use new black pipe and malleable fittings free of cutting and threading burrs or defects.
- A separate shut-off valve or gas cock for **EACH OVEN MUST** be **PROVIDED**. For stacked ovens, **EACH DECK** shall be considered a separate oven.
- **THE FLUE PIPE** from the draft hood must not run downward at any point from the oven to the final outlet. For horizontal runs, it must rise at least 1/4" inch per foot. **FOR BEST RESULTS;** the flue should rise straight up.
- **DO NOT USE A DAMPER IN THE FLUE, OR CONNECT A BLOWER DIRECTLY TO THE FLUE.** If the flue runs directly to the free air outside the building, use an approved wind deflector.
- When a ventilation hood is used, a flue deflector is mounted in place of the draft hood. The hood should be constructed at least as wide as the oven, and should overhang 6" to 12" (15cm to 30cm), forward of the oven. Its lower front edge should be 6'6" ft. (2M) from the floor.
- The main valve comes equipped with its own pressure tap.

**CAUTION:** Because it is difficult to accurately control pressure during supply pipe leak test, it is recommended that the Combination Valve be disconnected. Exposing the combination valve to a pressure over ½ psig, 14.0" w.c. (50 MBAR) will damage the valve and void all warranties.

**DANGER! Explosion hazard.**

**Do not use oxygen for pressure testing.  
An explosion could occur during initial start-up.**

WARNING: \* DO NOT MODIFY THIS APPLIANCE.

\* DO NOT BLOCK THE AIR REGISTERS ON THE OVEN AS THIS WILL CAUSE THE OVEN TO OVERHEAT.

WARNING: DO NOT USE THIS APPLIANCE IF ITS CONTROL HAS BEEN UNDER WATER. IMMEDIATELY CALL A QUALIFIED SERVICE TECHNICIAN TO INSPECT THE APPLIANCE AND TO REPLACE ANY PART OF THE COMPONENTS WHICH HAS BEEN UNDER WATER.

WARNING: ADEQUATE MEANS MUST BE PROVIDED TO LIMIT THE MOVEMENT OF CASTERED APPLIANCES. A RESTRAINING DEVICE IS REQUIRED FOR ALL TYPES OF MOVEABLE GAS APPLIANCES.

## **INSTALLATION**

**RECEIVING:** Immediately after receiving the oven, check for possible shipping damages. If this oven is found to be damaged, save the packaging material and contact the carrier within 15 days of delivery. Prior to installation, verify that the type of gas (natural or propane) agree with the specifications on the oven data plate, located on right exterior side panel. Do not use the door or the handle to lift oven.

**LOCATION:** Verify that the doors and access routes into kitchen area are checked for clearance. (When crate is turned on its side, the oven will pass through a 34" [864mm] door opening). The equipment area must be kept free and clear of combustibles. Maintain clearances from combustible or noncombustible construction of at least 3" (76mm) from the side and 3" (76mm) from the back of the oven. The installation location must allow adequate clearances for servicing and proper operation.

### **INSTALLING BASIC OVEN:**

1) Tilt oven on back side and fasten front legs to oven.

#### **STEP #1**

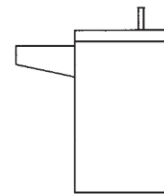

2) Tilt oven forward on front legs and lift from back until oven is resting on front legs.

#### **STEP #2**

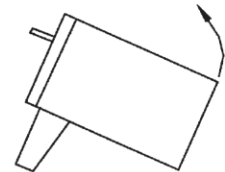

3) Place one of the remaining legs upside down so that large end of leg is resting on floor and place under back center of oven.

#### **STEP #3**

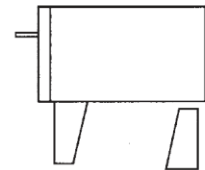

4) Attach the remaining leg and then lift the oven slightly removing the leg that was used as a brace, turn right side up, and install. When legs are securely fastened place oven.

#### **STEP #4**

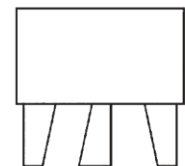

5) Install using screws supplied with oven one of the following.

#### **Draft Hood**

Used with a flue pipe to the exterior of the building

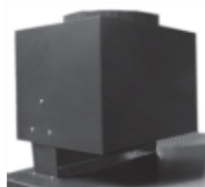

#### **Flue Deflector**

Used under a Ventilation hood

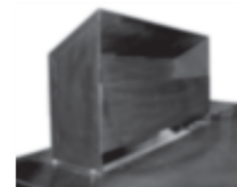

**STACKING OVENS:** Lift and place oven on top of bottom one. No fasteners are required, the weight of the oven will keep it in place. A separate shut-off valve or gas cock for **EACH OVEN MUST** be **PROVIDED**. For stacked ovens, **EACH DECK** shall be considered a separate oven. Single oven suggested 36" legs stacked ovens suggested 24" legs

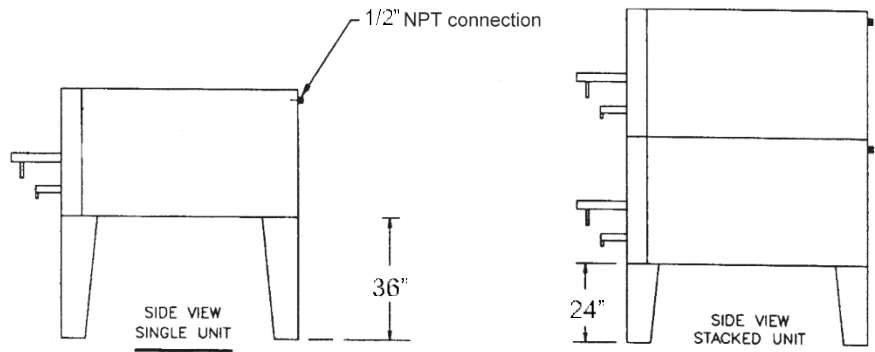

**INSTALLATION OF STONE HEARTH & UNDERSHEETS:**

**Step #1:** Install stainless steel trim on top of the bottom door frame.

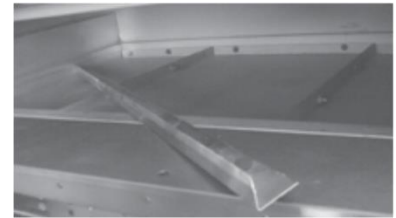

**Step #2:** Starting on the left side of oven, install undersheets placing the side with the flange on the right. Make sure the longer notch is towards the front resting on the stainless trim. The shorter notch rests on the rear ledge.

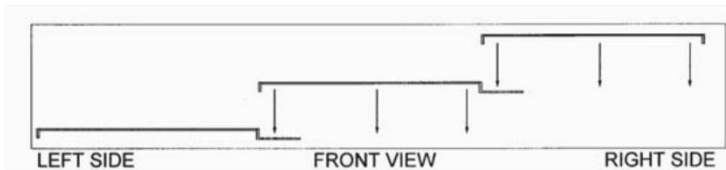
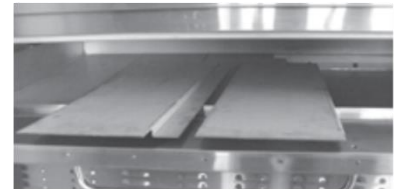

Basic position of undersheets

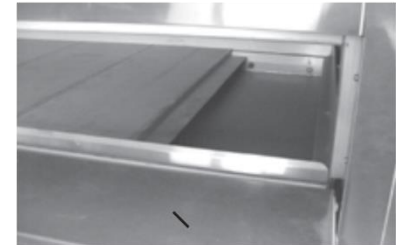

**Step #3:** Now place the stone hearth on top of steel undersheets.

**NOTE:** The hearth stones have the letter "B" stamped along one side the 36" length. The sides marked "B" should be placed together.

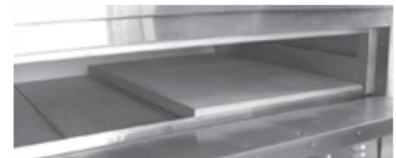

**Step #4:** Angle stoppers should then be placed on both sides of the stone hearth to compensate for the expansion of the metal when very hot.



**BREAKING-IN:** This process is simple and if done as indicated below, will assure a properly functioning oven.

**FOR “IMPERIAL” DECKS (STONE HEARTHS):** Set oven to 300° F (150° C) **FOR 2 HOURS**, raise oven temperature to 400° F (200° C) for 1 hour, raise oven temperature to 500° F (260° C) for 1 hour, raise oven temperature to 600° F (315° C) for 1 hour.

**DO NOT PUT WATER ON STONE HEARTH WHEN HOT.**

**FOR “STEEL” DECKS:** Set oven to 300° F (150° C) **FOR 1 HOUR**, Raise oven temperature to 450° F (232° C) for 1 hour, raise oven temperature to 600° F (315° C) for 1 hour.

## **CLEANING INSTRUCTIONS**

**NOTE: THE OVEN MUST BE COOL AS WATER OR CLEANING LIQUIDS APPLIED TO THE STONE HEARTH WHILE HOT CAN CAUSE HEARTH TO BREAK. DO NOT USE STRONG CLEANING AGENTS, STEEL WOOL OR WIRE BRUSHES ON STAINLESS STEEL SURFACES.**

1. Clean exterior surfaces of the oven by wiping it down with a mild detergent and clean water, or a commercial cleaner.
2. Clean the interior by sweeping up all loose particles. **DO NOT** use wire brushes or liquids on the stone hearths as this can cause them to break.
3. On exterior of oven, removal of deposits of baked-on splatter, oil, grease or light discolorations may be removed with any of several commercial cleaners. Consult with your local supplier.
4. Periodically, remove flue from unit and clean in a detergent and hot water. **NOTE:** Be sure to clean and inspect the ventilation hood on a regular basis.

### **PREVENTATIVE MAINTENANCE**

Although this oven has been designed to be as trouble free as possible, periodic Preventative Maintenance is essential to maintain peak performance. It is necessary to keep controls free of dirt, dust, and debris to insure proper cooling of components. Overheating is detrimental to the life of all the components. The periodic intervals for preventative cleaning may vary greatly depending upon the environment in which the oven is operating.



## TO CHANGE CARRY OVER TUBE OR BURNERS

Step #1: Open door and remove two screws holding panel.

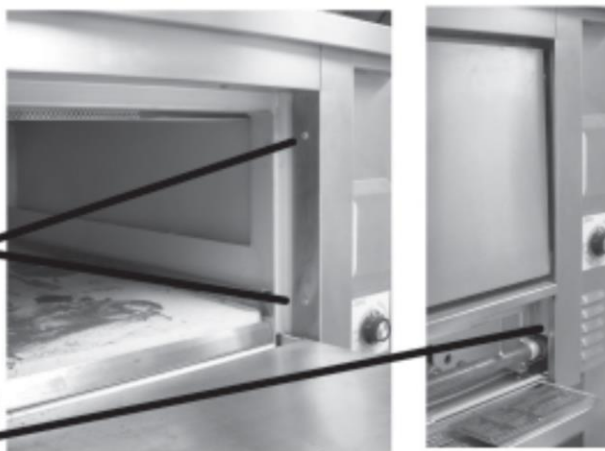

Step #2: Open bottom panel and remove screw.

Step #3: Remove control panel.

Step #4: Unscrew bracket holding manifold.

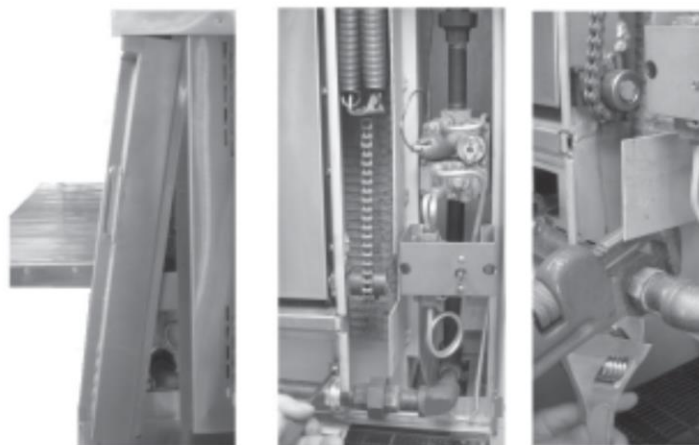

Step #5: Undo manifold.

Step #6: Remove last screws holding manifold taking it off.



Step #7: Remove second to last bracket support holding carry over tube.



Step #8: Remove remaining brackets.



Step #9: Remove tube holder with allen key and push tube behind.

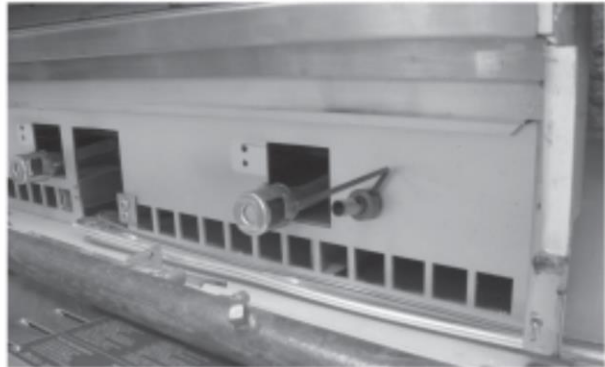

Step #10: Pull tube forward and remove end bracket.



Step #11: Pull out carry over tube and replace.

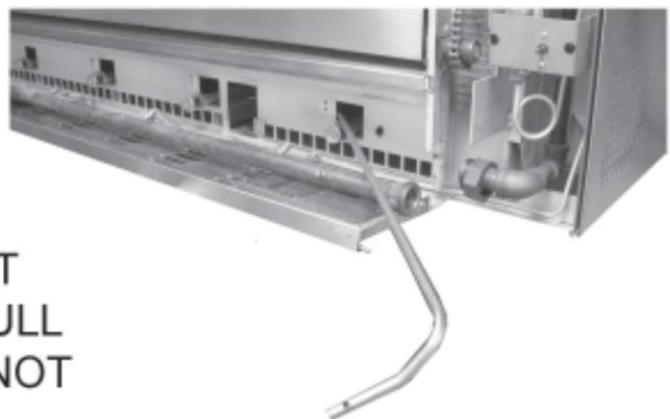

TO CHANGE BURNERS JUST REMOVE MANIFOLD AND PULL OUT BURNERS. THEY ARE NOT SCREWED DOWN.

## PARTS BREAKDOWN FOR THE MODELS SRPO-48G / SRPO-60G / SRPO-72G

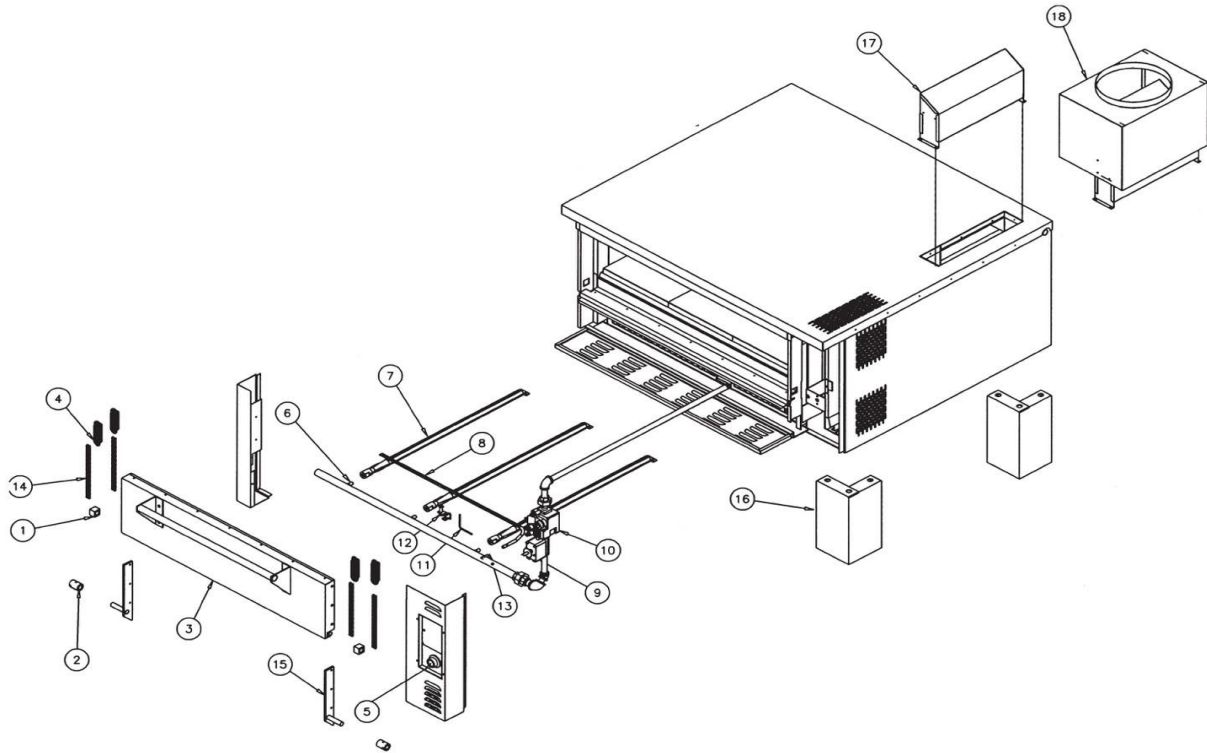

NO	PART #	DESCRIPTION	NO	PART #	DESCRIPTION
1	SIE-TEF005	S/S SQUARE BUSHING FOR HINGE	14	SIE-E200CH	DOOR CHAIN
2	SIE-TEF349	DOOR DRUM	14	SIE-E300CH	DOOR CHAIN
3	SIE-TEF257	DOOR ASSEMBLY FOR SPRO-48G	15	SIE-F272-L	DOOR HINGE LEFT SIDE
3	SIE-TEF259	DOOR ASSEMBLY FOR SPRO-60G	15	SIE-F272-R	DOOR HINGE RIGHT SIDE
3	SIE-TEF261	DOOR ASSEMBLY FOR SPRO-72G	16	SIE-P12	PAINTED LEGS 12"
4	SIE-CA200SP	DOOR SPRING	16	SIE-018	PAINTED LEGS 18"
5	SIE-RBKNOB	KNOB FOR THERMOSTAT	16	SIE-P24	PAINTED LEGS 24"
6	SIE-TE44	ORIFICE FOR BURNER (NATURAL)	16	SIE-P30	PAINTED LEGS 30"
7	SIE-TE55	ORIFICE FOR BURNER (PROPANE)	16	SIE-P36	PAINTED LEGS 36"
8	SIE-ML247	CARRY OVER TUBE ( MODEL SRPO-48G)	16	SIE-SS12	STAINLESS STEEL LEGS 12"
8	SIE-ML248	CARRY OVER TUBE ( MODEL SRPO-60G)	16	SIE-SS18	STAINLESS STEEL LEGS 18"
8	SIE-ML249	CARRY OVER TUBE ( MODEL SRPO-72G)	16	SIE-SS24	STAINLESS STEEL LEGS 24"
9	SIE-RB4200503	THERMOSTAT	16	SIE-SS30	STAINLESS STEEL LEGS 30"
10	SIE RB7000BGOR12	GAS VALVE	16	SIE-SS36	STAINLESS STEEL LEGS 36"
11	SIE-RB44348	THERMOCOUPLE	16	SIE-PC5	CASTERS 5"/SET
12	SIE-RB5CH1	PILOT	17	SIE-FD282A	FLUE DEFLECTOR
13	SIE-P47N	ORIFICE FOR CARRY OVER # 58 (NG) /SRPO-48G	18	SIE-DH291A	DRAFT HOOD
13	SIE-P48N	ORIFICE FOR CARRY OVER # 55 (NG) /SRPO-60G	19	SIE-ST1236112	HEARTH STONE 12"X36"X1.5"
13	SIE-P49N	ORIFICE FOR CARRY OVER # 53 (NG)/SRPO-72G	19	SIE-ST2436112	HEARTH STONE 24"X36"X1.5"
13	SIE-P47P	ORIFICE FOR CARRY OVER # 72 (LP) /SRPO48G			
13	SIE-P48P	ORIFICE FOR CARRY OVER # 68 (LP) /SRPO-60G			
13	SIE-P49P	ORIFICE FOR CARRY OVER # 65 (LP) /SRPO-72G			