



## PVC-500 FOOD PROCESSOR

- › Designed for slicing, grating and shredding on all types of vegetables, fruits and cheese
- › Machine shuts off if cover is opened
- › Cover is completely removable allowing for easy cleaning and changing of discs
- › Comes with 5 blades
- › Easy to operate
- › Durable design
- › Anodized aluminum
- › High power motor
- › No volt safety release

### 5 blades included

Additional blades available



GRATING 7MM   GRATING 4MM   GRATING 3MM   SLICING 4MM   SLICING 2MM



 514-737-9701  
  786-600-4687  
 TOLL FREE: 888-275-4538   TOLL FREE: 844-218-8477

5659 ROYALMOUNT AVE, MONTREAL, QC, CANADA H4P2P9  
3560 NW 56TH ST, FORT LAUDERDALE, FL, USA 33309

 MVPGROUPCORP.COM  
  SALES@MVPGROUPCORP.COM

PROJECT NAME: \_\_\_\_\_

LOCATION: \_\_\_\_\_

ITEM: \_\_\_\_\_ QTY: \_\_\_\_\_

MODEL: \_\_\_\_\_



MODEL	PVC-500
POWER	0.75 HP / 0.56 kW
AMPERAGE	5
WATTS	550
ELECTRICAL	110V/60/1
DISC SPEED	270 RPM
HOPPER OPENING	5.11" x 2.16"
WEIGHT (NET/GROSS)	50.6 lbs / 55 lbs
DIMENSIONS (DWH)	19" x 9" x 19.70"
PACKAGING DIMENSIONS	22" x 12" x 23"



Intertek



Intertek



NEMA-5-15P



**Warranty: One year parts & labor, carry in exclusive of wear items**

Specifications subject to change without notice

"PRIMO" is a registered trademark of MVP Group Corp.







Printed May 2018



# PVC-500 FOOD PROCESSOR



**Accessories** – Sold Separately \*All blades needs to work with an ejector disc

DICING	GRID CUT	SLICING	JULIENNE	SLICING	SLICING
					
<b>D20</b> 20x20x10mm	<b>T10</b> 10x10mm	<b>H10</b> 10x10mm	<b>HU10</b> 10x10mm	<b>H-14</b> 14mm	<b>E5</b> 5mm
<b>D12</b> 12x12x10mm	<b>T8</b> 8x8mm	<b>H8</b> 8x8mm	<b>HU8</b> 8x8mm		<b>E2</b> 2mm
<b>D10</b> 10x10x10mm	<b>T6</b> 6x8mm		<b>HU4</b> 4x4mm		<b>E1</b> 1mm
<b>D8</b> 8x8x8mm	*Needs to work with a slicing blade		<b>HU2.5</b> 2.5x2.5mm		

\*Needs to work  
with a slicing  
blade

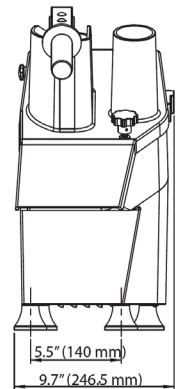
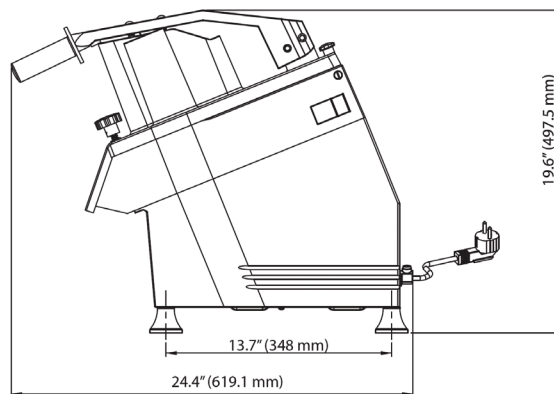
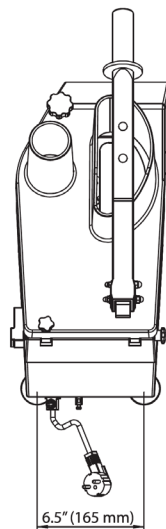

🇨🇦 514-737-9701 
 🇺🇸 786-600-4687  
 TOLL FREE: 888-275-4538 
 TOLL FREE: 844-218-8477

5659 ROYALMOUNT AVE, MONTREAL, QC, CANADA H4P2P9  
3560 NW 56TH ST, FORT LAUDERDALE, FL, USA 33309

[MVPGROUPCORP.COM](http://MVPGROUPCORP.COM) 
 ✉ [SALES@MVPGROUPCORP.COM](mailto:SALES@MVPGROUPCORP.COM)

**Warranty: One year parts & labor, carry in  
exclusive of wear items**

Specifications subject to change without notice

\*PRIMO is a registered trademark of MVP Group Corp.

Printed May 2018