



**"WE MAKE THE KITCHEN BETTER!"**

**ATOSA USA, INC.**

**Toll Free: 855-855-0399 Email: info@atosausa.com**

www.atosa.com | www.atosausa.com

California, Colorado, Florida, Georgia, Illinois,  
New Jersey, Ohio, Texas, Washington

# Mega Top Sandwich Prep Tables

## Standard Features

- Stainless steel exterior & interior
- Rear mount compressor with environmentally friendly R290 refrigerant
- Concentrated airflow design for even distribution of airflow around pans. Unmatched cabinet airflow design
- Electronic Temperature Controller
- Removable stainless steel pan liner
- Maintains temperatures between 33°F - 40°F
- Locking divider bars
- Pre-installed 6" deep poly pans
- 10" cutting board
- Recessed door handle(s)
- Self-closing door(s) with stay open feature
- Magnetic door gasket(s) standard for positive door seal
- One(1) pre-installed shelf per section
- Pre-installed casters

## Optional Accessories

- Double overshelf for 27", 36", 48", 60" and 72" models
- Part # 82021902 - 12" cross bar
- Night covers



For the best results of food preservation we recommend setting your refrigerator between 33°F to 38 °F

1. Don't forget to leave the unit some room to breathe!
2. Please clean the condenser frequently to give the unit more fresh air.



2 YEAR PARTS AND LABOR WARRANTY  
5 YEAR COMPRESSOR PART WARRANTY

## MODELS:

MSF8305GR / MSF3615GR  
MSF8306GR / MSF8307GR / MSF8308GR



**MSF8305GR**



**MSF3615GR**



**MSF8306GR**



**MSF8307GR**



**MSF8308GR**





**"WE MAKE THE KITCHEN BETTER!"**

**ATOSA USA, INC.**

**Toll Free: 855-855-0399 Email: info@atosausa.com**

www.atosa.com | www.atosausa.com

California, Colorado, Florida, Georgia, Illinois,

New Jersey, Ohio, Texas, Washington

## SPECIFICATIONS

Models	Door	Capacity (Cu.Ft.)	Shelves	Casters (inch)	Amps (A)	Voltage (V/Hz/Ph)	HP	Refrigerant	Exterior Dimensions (inch)	Net Weight (lbs)	Gross Weight (lbs)
MSF8305GR	1	7.2	1	2	2.3	115/60/1	1/7	R290	27 <sup>1/2</sup> ×34×46 <sup>5/8</sup>	170	212
MSF3615GR	2	8.7	2	2	2.3	115/60/1	1/7	R290	36 <sup>5/16</sup> ×34×46 <sup>5/8</sup>	174	240
MSF8306GR	2	13.4	2	2	2.3	115/60/1	1/7	R290	48 <sup>1/5</sup> ×34×46 <sup>5/8</sup>	243	293
MSF8307GR	2	17.2	2	2	2.8	115/60/1	1/5	R290	60 <sup>1/5</sup> ×34×46 <sup>5/8</sup>	284	340
MSF8308GR	3	21.1	3	2	2.8	115/60/1	1/5	R290	72 <sup>7/10</sup> ×34×46 <sup>5/8</sup>	331	401

## PLAN VIEW

**MSF8305GR**

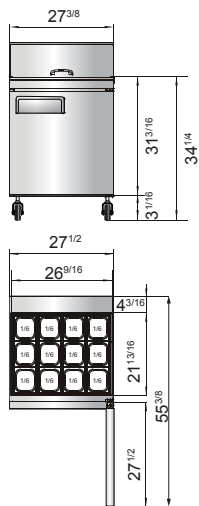

**MSF3615GR**

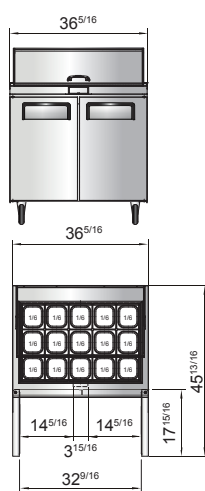

**MSF8306GR**

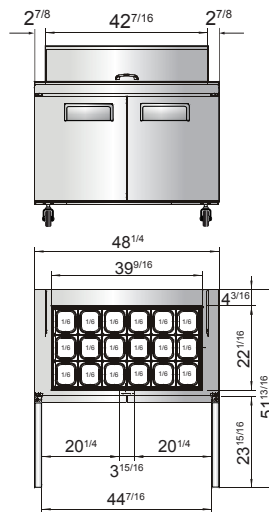

**SIDE VIEW**

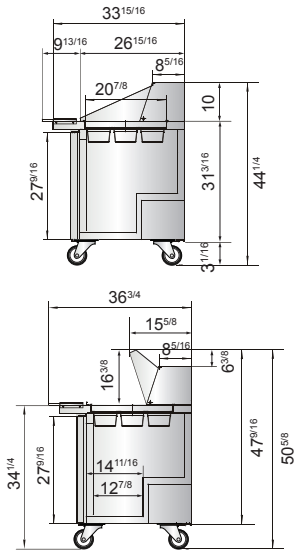

**MSF8307GR**

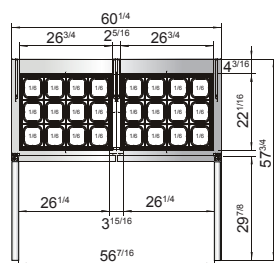
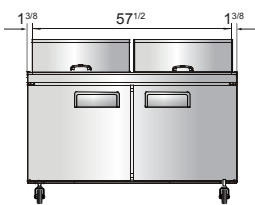

**MSF8308GR**

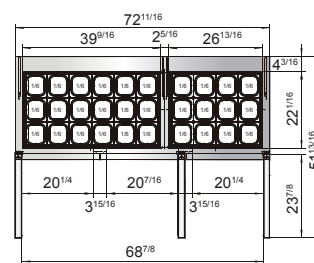
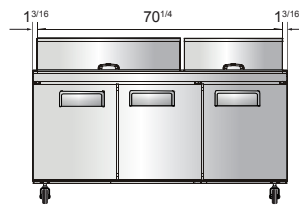

Stainless steel pan liner

Concentrated airflow design for even distribution of airflow around pans

Unmatched cabinet airflow design

Locking divider bars

