



OPEN AIR MERCHANDISER

KGG-36, KOM – 36 - 48 SS



5659 Royalmount Ave.
Montreal, QC, Canada H4P 2P9
Telephone: 514.737.9701 / Toll Free: 888.275.4538
Fax: 514.342.3854 / Toll Free: 877.453.8832
sales@mvpgroupcorp.com / mvpgroupcorp.com

12000 Biscayne Blvd., Suite # 108
Miami, FL, United States 33181
Telephone: 786.600.4687 / Toll Free: 844.218.8477
Fax: 786.661.4100



Thank you for choosing and purchasing our product. Please carefully read the operation instructions before use.

Contents

- General
- Structure and Parts
- Handling and Safety
- Preparation and Power Supply
- Use and Caution
- Maintenance
- Troubleshooting
- Circuit Diagram



5659 Royalmount Ave.
Montreal, QC, Canada H4P 2P9
Telephone: 514.737.9701 / Toll Free: 888.275.4538
Fax: 514.342.3854 / Toll Free: 877.453.8832
sales@mvpgroupcorp.com / mvpgroupcorp.com

12000 Biscayne Blvd., Suite # 108
Miami, FL, United States 33181
Telephone: 786.600.4687 / Toll Free: 844.218.8477
Fax: 786.661.4100



General

This product is a new chilling cabinet which adds to our extensive refrigeration product lines. These units are primarily designed for beverages, dairy products, vegetables and fruits.

Structure and Parts

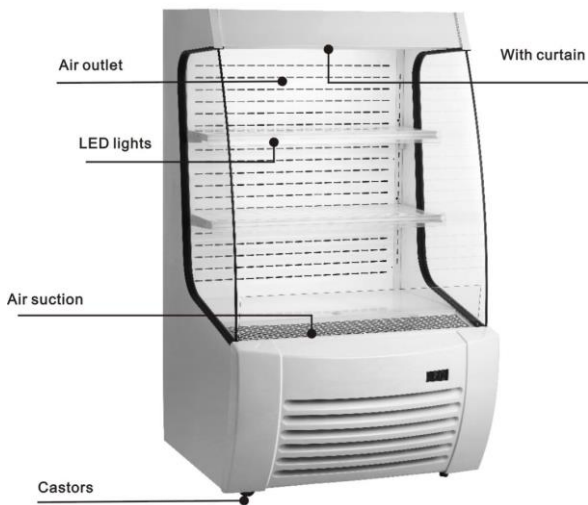

Parameter	KGG-36	KOM-36 SS
Coolant and injection quantity(g)	R-404a	R-404a
General Rated input power(W)	1260	1260
Power running(rating) of electrical heating element(W)	450-536	450-536
Max.ambient temp./RH	<27° C (80.6°F) /70%	<27° C (80.6°F) /70%
Refrigeration Temperature(°C)	1° - 4°	1° - 4°
Rated voltage(V)	115	115
Rated frequency(Hz)	60	60
Rated current(A)	11.6	11.6
Foaming agent	C5H10	C5H10
Lamp power(W)	2.8*2(LED	2.8*2(LED)
Total effective volume(L)	320	320
Overall dimension(inch) (LxWxH)	36.2 x 33.3 x 59.4	36.1 x 31.2 x 57.4



5659 Royalmount Ave.
 Montreal, QC, Canada H4P 2P9
 Telephone: 514.737.9701 / Toll Free: 888.275.4538
 Fax: 514.342.3854 / Toll Free: 877.453.8832
 sales@mvpgroupcorp.com / mvpgroupcorp.com

12000 Biscayne Blvd., Suite # 108
 Miami, FL, United States 33181
 Telephone: 786.600.4687 / Toll Free: 844.218.8477
 Fax: 786.661.4100



Handling and Safety

Handle with care

Unplug the wall socket first.

Never tilt the unit over 45 degrees during handling.



Dry place

Always place the refrigerator in a dry place.



Sufficient space

There must be a min 10 cm clearance around all sides of the unit.

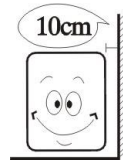

Well ventilation (ventilated)

Always locate the refrigerator in a well ventilated area. The first time you use the unit, wait 2 hours after handling the unit before plugging it in.

After handling the or moving the unit, wait 2 hours before plugging the unit in to allow the compressor to stabilize

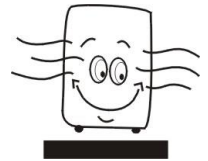

Far from heat source

Never place the refrigerator directly in the sunlight. Never put the refrigerator near any heat source or heater as this will reduce the refrigerators capability.

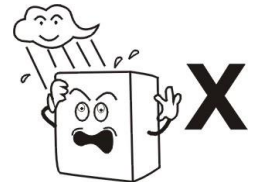

No heavy load

Never put any heavy items on top of the refrigerator.

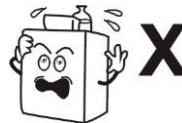

No hole making

Never make holes in the refrigerator.

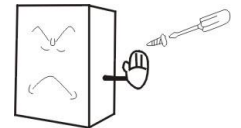

Stable location

Unpack and locate the refrigerator on a flat, solid surface.

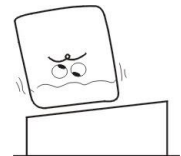

5659 Royalmount Ave.
Montreal, QC, Canada H4P 2P9
Telephone: 514.737.9701 / Toll Free: 888.275.4538
Fax: 514.342.3854 / Toll Free: 877.453.8832
sales@mvpgroupcorp.com / mvpgroupcorp.com

12000 Biscayne Blvd., Suite # 108
Miami, FL, United States 33181
Telephone: 786.600.4687 / Toll Free: 844.218.8477
Fax: 786.661.4100

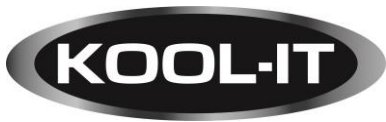

ADDITIONAL WARNINGS:



Caution: risk of fire. The height of the triangle in the symbol must be at least 15mm.



Do not dispose of electrical appliances as unsorted municipal waste, use a separate collection facilities. Contact you local government for information regarding the correct way to dispose.

Preparation and Power Supply

Exclusive power socket

The power supply should be in a 115/60 single phase AC with exclusive single phase three pin receptacle.

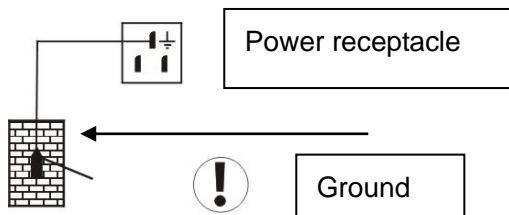

Must be on a dedicated circuit

Refrigerator needs to be on a dedicated circuit.

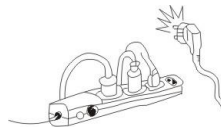

Protect cables

Never break or damage the cables. Replace any damaged, frayed or cut cables.

Do not spray water in the unit

Never spray the unit directly with water.

Keep away from flammables and explosives.

Never put any flammable or explosives inside the refrigerator (such as ether, gasoline, alcohol, adhesive or explosive). Never put any dangerous products near the refrigerator.

Do not spray unit with flammables

Do not spray the unit with flammables such as aerosols or cleaning products near the refrigerator.

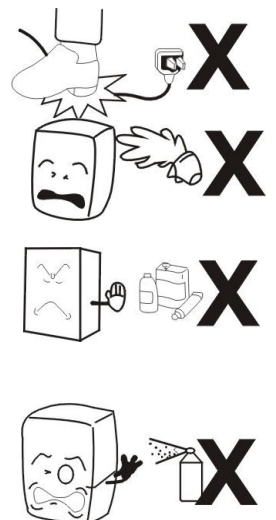

5659 Royalmount Ave.
Montreal, QC, Canada H4P 2P9
Telephone: 514.737.9701 / Toll Free: 888.275.4538
Fax: 514.342.3854 / Toll Free: 877.453.8832
sales@mvpgroupcorp.com / mvpgroupcorp.com

12000 Biscayne Blvd., Suite # 108
Miami, FL, United States 33181
Telephone: 786.600.4687 / Toll Free: 844.218.8477
Fax: 786.661.4100



After a power outage

After a power outage unplug the refrigerator and wait at least 5 minutes before plugging in and restarting the refrigerator

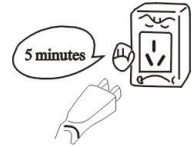

No medicine

Medicines should not be stored inside the refrigerator.



Use and Caution

1. Before use:

Plug the refrigerator in a dedicated outlet designed for the power rating of the unit.



This appliance is not intended for use by unauthorized individuals as well as individuals with reduced physical, sensory or mental capabilities, or lack of experience and knowledge, unless they have been given supervision or instructions concerning the use of the appliance by a person responsible for their safety. Children should be supervised to ensure that they do not play with the appliance.

2. Digital Temperature controller

Front Panel Operation

1. Set temperature

Press the set button, the default temperature that is currently set at will be displayed.

Press  or  button to modify and store the modified value.

Press the set button, this will save the new temperature

If for 10 seconds there is no response, the temperature will revert back to the default settings.

2. Lights: Press button, if the lights turn on ; Press again, and they will turn off.

Manually start/stop the defrost : Press  button and hold for 6 seconds to start the defrost or stop the defrost.

3. Defrost LED: As the unit is cooling, the LED will stay on. When the temperature of the unit is at the set temperature the LED will be off. If there is a delay in the start then the LED will flash.

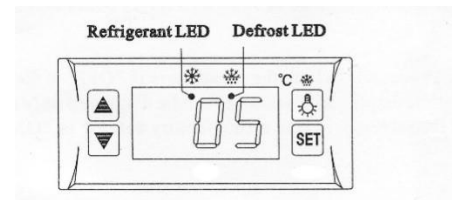

5659 Royalmount Ave.
Montreal, QC, Canada H4P 2P9
Telephone: 514.737.9701 / Toll Free: 888.275.4538
Fax: 514.342.3854 / Toll Free: 877.453.8832
sales@mvpgroupcorp.com / mvpgroupcorp.com

12000 Biscayne Blvd., Suite # 108
Miami, FL, United States 33181
Telephone: 786.600.4687 / Toll Free: 844.218.8477
Fax: 786.661.4100

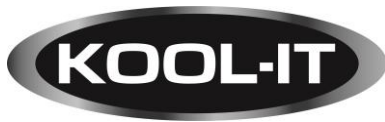

Maintenance

1. The product needs to be cleaned once a week with the power supply disconnected. While cleaning please use a mild rinsing water or non-corrosive detergent. Do not wash it directly with water.
2. Cleaning for filter
To keep the device in good working condition, the condenser needs to be cleaned every month. When the message “EE4” appears on the display, please clean the condenser immediately. After cleaning, if message “EE4” appearing again, please contact service.
3. Check if the unit is leaking. Observe all the connectors and welding joints for any oil stains. If there are any oil stains call service.
4. Frequently observe the operation of the product. In case of any abnormal noise, smell or smoke, cut off the power supply immediately and call for service
. Do not restart the product before the issue has been rectified.
5. MVP Group will not be liable for any accident incurred or failures that occurs due to actions that do not follow the guidelines indicated in the manuals.

Troubleshooting

	Causes	Solutions
Strange noise under the bottom shelf	Fan blade broken	Call Service, the fan blade needs to be replaced.
Unit is not getting cold.	<ol style="list-style-type: none"> 1. Unit is off. 2. Refrigerant leaking 3. Unit has failure 	Call Service
Defrost Water overflowing	<ol style="list-style-type: none"> 1. Heating tube is damaged 2. Water-level controller failure 3. Ambient temperature or humidity is above the recommended settings. 	<ol style="list-style-type: none"> 1. Replace the heating tube 2. Replace the water-level controller 3. Improve the conditions
Normal air curtain, but periodical fluctuation of cabinet temperature	<ol style="list-style-type: none"> 1. Condenser contaminated 2. Poor venting of the unit 3. Heat protection of compressor failure 4. Capillary is blocked by ice 5. Temperature controller failure 	<ol style="list-style-type: none"> 1. Clean the condenser 2. Improve the venting conditions 3. Replace the heat protection 4. Replace the filter 5. Replace the temperature controller

Note

The murmur of water is heard when the refrigerator is working. It is a normal occurrence as the coolant is circulating in the system. Condensation might be found on the outside of the refrigerator. This is caused by high humidity. Simply use a cloth to wipe it.



5659 Royalmount Ave.
 Montreal, QC, Canada H4P 2P9
 Telephone: 514.737.9701 / Toll Free: 888.275.4538
 Fax: 514.342.3854 / Toll Free: 877.453.8832
sales@mvpgroupcorp.com / mvpgroupcorp.com

12000 Biscayne Blvd., Suite # 108
 Miami, FL, United States 33181
 Telephone: 786.600.4687 / Toll Free: 844.218.8477
 Fax: 786.661.4100



Circuit Diagram

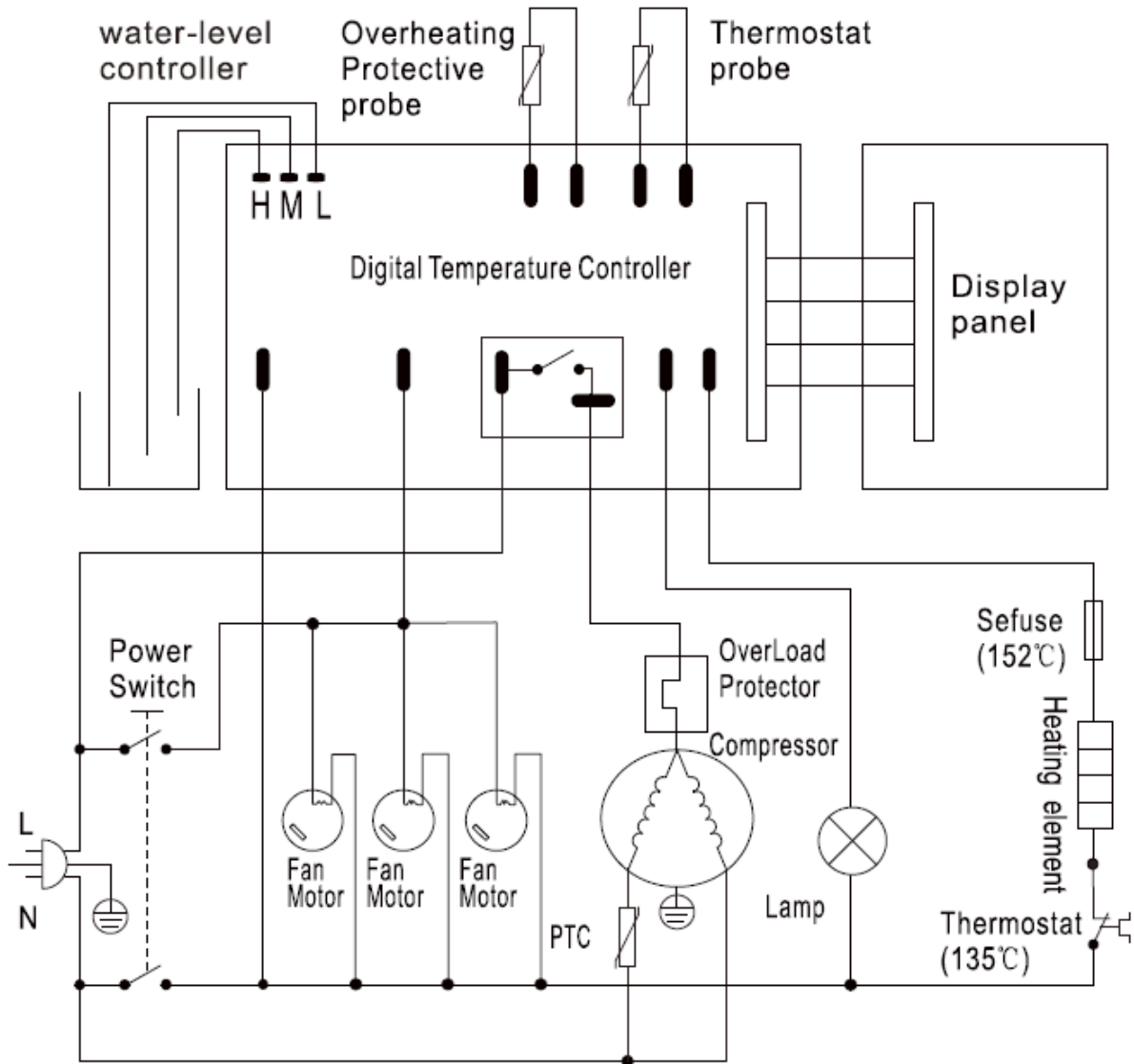

5659 Royalmount Ave.
Montreal, QC, Canada H4P 2P9
Telephone: 514.737.9701 / Toll Free: 888.275.4538
Fax: 514.342.3854 / Toll Free: 877.453.8832
sales@mvpgroupcorp.com / mvpgroupcorp.com

12000 Biscayne Blvd., Suite # 108
Miami, FL, United States 33181
Telephone: 786.600.4687 / Toll Free: 844.218.8477
Fax: 786.661.4100